

**SHIELD**<sup>TM</sup>  
*Trusted Worldwide*



# HDPE

PIPING SYSTEM

Complete Engineering Solution from one Source

**Gas**



**Fire**

**Water**



# INTRODUCTION

At SHIELD, we are dedicated to serving the needs of the fire protection and building services industries. We have a comprehensive range of quality products designed to the highest local and international standards.

Our commitment to continued research and development ensure that we remain at the forefront of innovative products to bring to the marketplace.

Our worldwide manufacturing facilities are some of the most advanced in the industry. Our experienced and professional staff provide the highest levels of service across engineering, quality, manufacturing, and after-sales support.

With our highly responsive and customer-focused network of distribution centres around the world, we excel at providing outstanding levels of service to our customers.

With offices and facilities in the UK and the Middle East, we can cater to the specific needs of your region and we are justifiably proud of our global client base.

At our manufacturing facility, in the UAE, we produce UL Listed, FM Approved, WRAS approved, and Bureau Veritas approved PE Pipes and fittings for use across a wide range of industries and applications in the region.

# TABLE OF CONTENTS

<b>1 - 10</b>	<b>HDPE System</b>
1	<i>Introduction</i>
2	<i>Characteristics of HDPE</i>
5	<i>Physical Properties of HDPE</i>
5	<i>Minimum Required Strength</i>
6	<i>Automated Quality Control System</i>
7	<i>Design Stress &amp; Safety Factor</i>
7	<i>Pipe SDR &amp; Pressure Relationships</i>
8	<i>Pressure Reduction Co-efficient</i>
9	<i>Manufacturing Process</i>
10	<i>Quality Control</i>
<b>11 - 14</b>	<b>Water Line</b>
11	<i>Technical Data PE100 - ISO 4427</i>
12	<i>Technical Data PE80 - ISO 4427</i>
13	<i>Technical Data Bore Size PE80- ISO 4427</i>
14	<i>Technical Data - ANSI/AWWA C906</i>
15	<i>HDPE Pipe Selection</i>
<b>16</b>	<b>Gas Line</b>
16	<i>Technical Data - ISO 4437 &amp; BS EN 1555</i>
<b>17</b>	<b>Fire Line</b>
17	<i>Technical Data</i>
17	<i>Hydrant Installation</i>
<b>18</b>	<b>Drainage Line</b>
18	<i>Technical Data - BS EN 1519-1</i>
<b>19</b>	<b>HDPE Fittings</b>
19	<i>Introduction</i>
<b>21 - 29</b>	<b>Moulded Fittings - ISO 4427</b>
22	<i>90°Elbow</i>
23	<i>45°Elbow</i>
24	<i>Equal Tee</i>
25	<i>Concentric Reducer</i>
27	<i>Stub Flange</i>
28	<i>Short Stub Flange</i>
29	<i>End Cap</i>
<b>30 - 34</b>	<b>Segmented Fittings - ISO 4427</b>
31	<i>90°Elbow</i>
32	<i>45°Elbow</i>
33	<i>60°/30°/22.5°/11.25°Elbow</i>
34	<i>Equal Tee</i>
35	<i>Reducer Tee</i>
36	<i>Cross Tee</i>
<b>37 - 41</b>	<b>Moulded Fittings - ANSI/AWWA C906</b>
38	<i>90°Elbow</i>
39	<i>45°Elbow</i>
40	<i>Equal Tee</i>
41	<i>Concentric Reducer</i>
42	<i>Stub Flange</i>

# TABLE OF CONTENTS

<b>Segmented Fittings - ANSI/AWWA C906</b>	<b>42 - 48</b>
90°Elbow	43
45°Elbow	44
60°/30°/22.5°/11.25°Elbow	45
Equal Tee	46
Reducer Tee	47
Cross Tee	48
<b>Fitting Accessories</b>	<b>49 - 56</b>
Galvanized Backing Ring - BS 4504/EN 1092-1	50
Stainless Steel Backing Ring - BS 4504/EN 1092-1	51
Steel Blind Flange - BS 4504/EN 1092-1	52
Galvanized Backing Ring - ANSI/ASME B16.5	53
Stainless Steel Backing Ring - ANSI/ASME B16.5	54
Steel Blind Flange - ANSI/ASME B16.5	55
EPDM Rubber - Gasket	56
<b>Electro-Fusion Fittings</b>	<b>57 - 59</b>
<b>Fusion Machines</b>	<b>60 - 63</b>
Butt-Fusion Machines	61
Facts & Benefits of Butt-Fusion	61
Range of Butt-Fusion Machines	62
Range of Electro-Fusion Machines	63
<b>Machine Accessories</b>	<b>64</b>
<b>Installation Manual</b>	<b>66 - 77</b>
Joining Methods	67
Heat Fusion Welding	68
Electro-Fusion	68
Butt-Fusion	69
Socket Fusion Joints	70
Mechanical Assembly	70
Installation Procedures	71
Site Conditions	71
Installation Methods	71
Underground Installation of HDPE Piping	73
Allowable Deflection	73
Above Ground Applications for HDPE Pipe	75
Anchorage and Thrust Blocks	75
Testing & Commissioning	76
Hydrostatic Pressure Pipeline Testing	76
HDPE Piping Hydro-testing Procedures	77
<b>Health &amp; Safety</b>	<b>78 - 79</b>
<b>Handling &amp; Storage</b>	<b>80 - 85</b>
<b>Certificates &amp; Approvals</b>	<b>86</b>
<b>Standards &amp; Abbreviations</b>	<b>90</b>

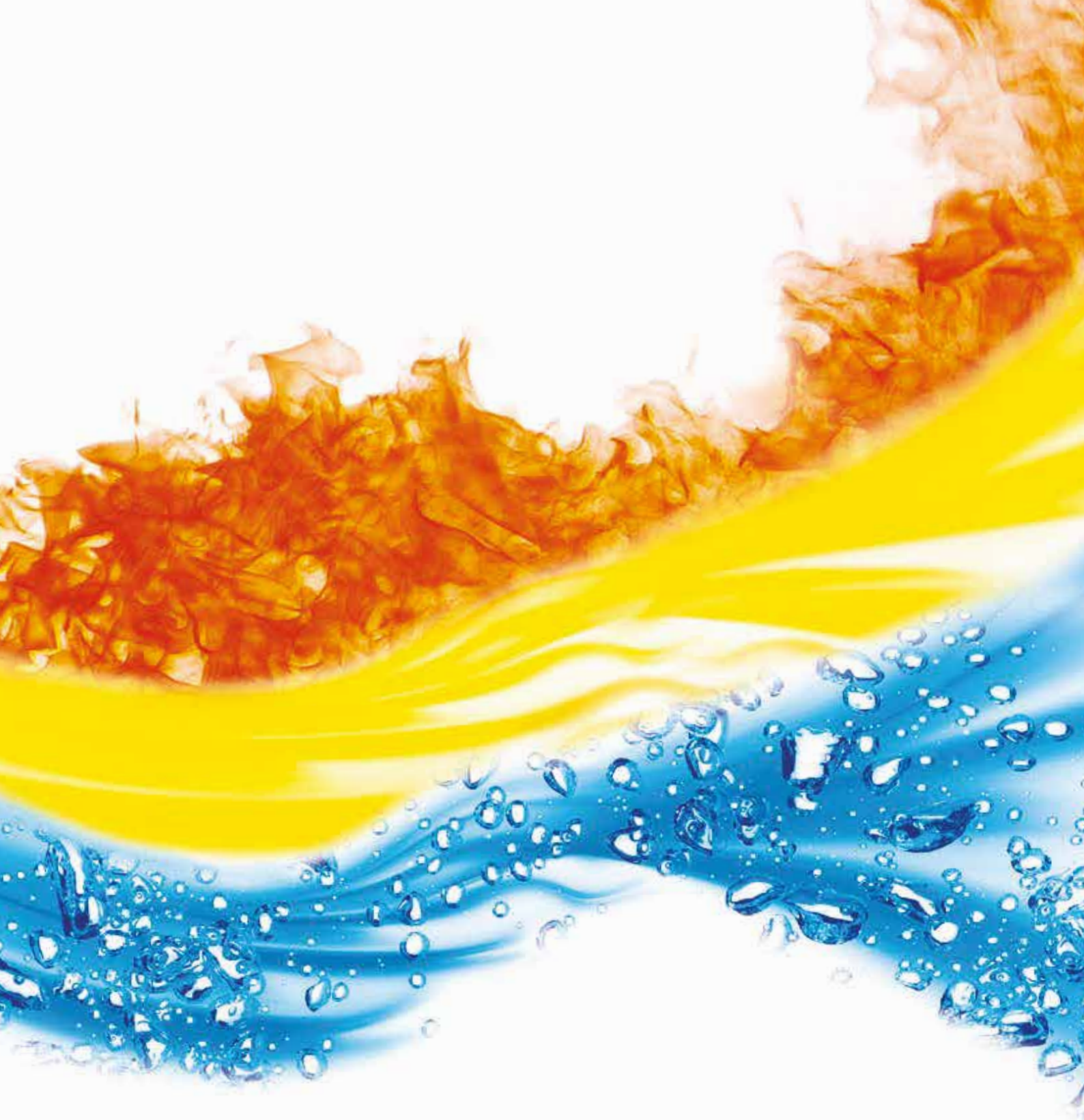

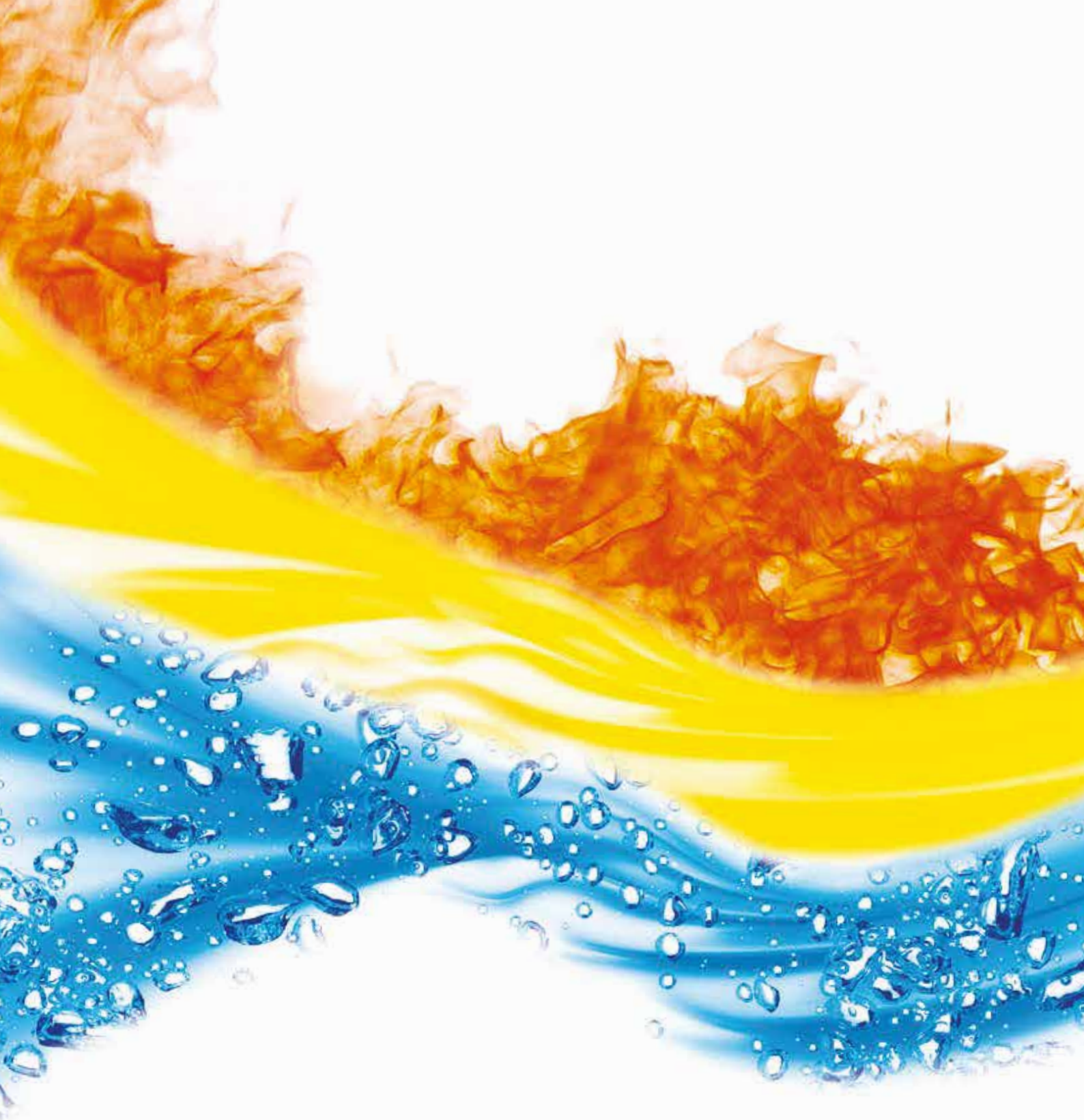

# HDPE System

**SHIELD**<sup>TM</sup>  
Trusted Worldwide



**WRAS**  
Water Regulations Advisory Scheme

Through a comprehensive and quality focused research program, SHIELD has been leading the industry for manufacturing and supply of HDPE piping system.

SHIELD HDPE pipes and fittings are manufactured as per ISO and AWWA Standards. Products are required to pass strict quality control procedures, and are rigorously monitored throughout the production process, from the inspection of raw materials to the storage of the finished products, to ensure their compliance with relevant quality standards. Review of existing facilities and continual improvements is always a priority, parallel to the consistent production process.

SHIELD High Density Polyethylene Pipes and Fittings are durable and strong for long life installation. This piping system is an effective solution for municipal, industrial, marine, agricultural and firefighting applications. Its efficiency has been tested and proven for above ground, surface, buried, slip lined, floating and sub-surface applications.

SHIELD HDPE is capable of meeting all your piping requirements.

**Factory  
Mutual  
System**





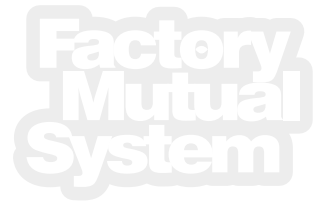

Material	Standards	Sizes	Applications
<ul style="list-style-type: none"><li>▶ High Density Polyethylene</li></ul>	<ul style="list-style-type: none"><li>▶ ISO</li><li>▶ AWWA</li></ul>	<ul style="list-style-type: none"><li>▶ 20 mm - 2000 mm</li><li>▶ 4" - 42"</li></ul>	<ul style="list-style-type: none"><li>▶ Fire Fighting (Underground)</li><li>▶ Irrigation</li><li>▶ Potable Water</li><li>▶ Drainage</li><li>▶ Gas</li><li>▶ Insulation/Sleeves/Jacket</li><li>▶ Directional Drilling/Marine</li></ul>

# HDPE System

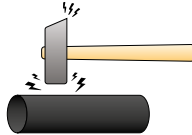
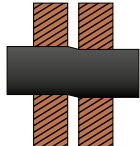
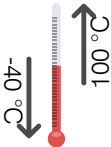
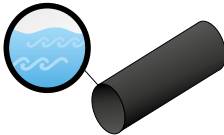
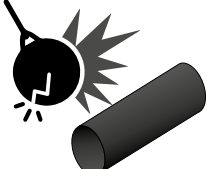
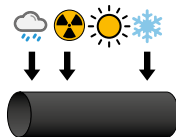
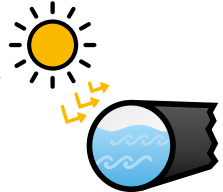

## Characteristics of PE:

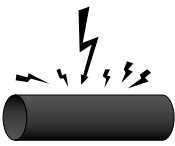
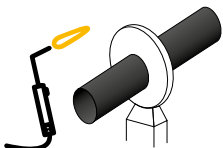
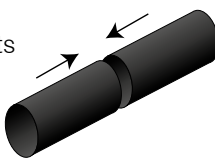
The figure summarizes many of the key characteristics of the HDPE like:

- 1 Impact Resistant 
- 2 Elastic 
- 3 Thermal Resistant 
- 4 Smooth Internal Wall 
- 5 Wear Resistant 
- 6 Weather-resistant / UV Resistant 
- 7 Poor Heat Conductivity 
- 8 Non-toxic   
PE-HD
- 9 Insulating 
- 10 Highly Suitable for Welding 
- 11 Homogeneous Welded Joints 
- 12 Prefabrication 
- 13 Light Weight 



# HDPE System

We recommend SHIELD HDPE piping solution due to its renowned following characteristics:



## High Impact Resistance:

(Also referred to as toughness)  
This might be one of the most important properties needed in transferring fluids. It is mainly about how strongly this material can withstand a sudden internal or external hit (normally for a buried pipe, a sudden pressure wave inside pipe). This property report the amount of energy this material is capable of absorbing before deforming.



## Elasticity:

Despite being very rigid, HDPE stays a polymer material, and this means high degree of elasticity and flexibility. The implications of this are high impact resistance, flexibility and minimum possibility of damaging HDPE material because of rough trench conditions or reduction of massive number of bends. This characteristic also implies that using these flexible pipes is safer especially in applications that need seismic protection.



## Thermal Resistance:

The operational safe temperature range of HDPE starts in the cold side from -40°C and ends in the hot side at about 100°C, and this range includes most of applications except the heating applications.



## Smooth Internal Wall:

The PE pipe interior is very smooth and guarantees decent flow. Not only this, the smoothness lifetime is much larger than that of steel or ductile iron because PE doesn't rust or rot. The free flow eliminates the possibility of internal deposits which make the inner diameter smaller.



## Wear Resistance:

High yield strength, high toughness, and high tensile stress the HDPE resists hard ambience. Even if the bedding used for this type of pipes contains large granules of rock and sand, this material can withstand up to granule diameter size of 65 mm which is really superb.



## Weather Resistance:

This property is an extension of thermal resistance and wear resistance properties, which means it can be left in any weather no matter how hard it is and nothing will happen to it. SHIELD HDPE products are UV stabilised carbon black protected.

**Factory  
Mutual  
System**

# HDPE System



## Poor Heat Conductivity:

This is one of the most useful properties of HDPE that make it suitable for the applications where it is necessary to secure absence of heat leakage either in or out, like HVAC applications.

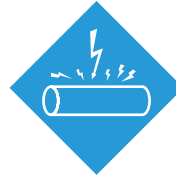

## Insulation/Sleeve:

This is another property that assures it is always very safe to use HDPE pipes even close to the areas where electric wires may pass or cross. HDPE is a bad conductor for electric current.



## Non-Toxic:

This property is inherent from the fact that the HDPE material is inert so the water inside will always be clean and safe. This is a big advantage when HDPE is compared to metal pipes for conveyance of potable drinking water.

## Characteristics

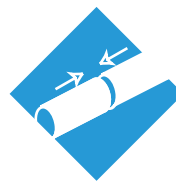

## Homogeneous Welded Joints:

Many technicians always complain that the welding remains a critical process for the metal pipes, because, the rigidity of metal prevents the full homogeneity of the welding area. While with HDPE, welding is more powerful especially in butt welding, that makes the joints share same properties of the pipe, and even are stronger.

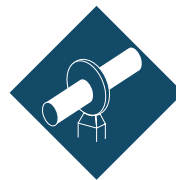

## Highly Suitable for Welding:

The main process used for manufacturing HDPE pipes is extrusion which is a hot forming process, that ensures high homogeneity for the end product, which leads to homogeneous formation of the molten material at the time of welding.



## Pre-Fabrication:

The HDPE is friendly for pre-fabrication to make customised products, for example segmented fittings can be pre-fabricated from the pipes of same SDR.



## Lightweight:

The light weight nature of HDPE pipes and fittings makes it easy for handling and installation in comparison to other materials.

# HDPE System

## Physical Properties of HDPE:

Characteristics	Units	PE 80	PE 100	Test Standards
Density	gm/cm <sup>3</sup>	≥ 0.93	≥ 0.95	BS EN ISO 1183
Minimum Required Strength (MRS)	MPa	8	10	BS EN ISO 1167
Design Stress	MPa	6.4	8	BS EN ISO 1167
Tensile Strength At Yield	N/mm <sup>2</sup>	18 - 23	23 - 25	BS EN ISO 527
Flexural Modules (Bend Creep)	N/mm <sup>2</sup>	650 - 850	1000 - 1200	BS EN ISO 527
Elongation At Break	%	> 600	> 600	ISO 527
Crystallite Melt Range	°C	128 - 132	128 - 132	DIN 53736
Surface Resistance	Ohm	10 <sup>13</sup>	> 10 <sup>14</sup>	ASTM D 257, DIN IEC 167
Coefficient Of Linear Expansion	mm/m*k	0.2	0.13	DIN 53752
Heat Conductivity At 20 °C	W/m*K	0.43	0.38	BS EN 12664, DIN 52612
Impact Strength At 23 °C	Kj/m <sup>2</sup>	110	83	BS EN ISO 179
Brittleness Temperature	°C	< -70	< -70	ASTM D746
Shore Hardness	D	65	62	ISO 868
Melt Flow Rate (Melt Flow Index - Mfi)	g/10min	0.2 - 1.4	0.2 - 1.4	ISO 1133
Water Absorption	%	0.01 - 0.04	0.01 - 0.04	BS EN ISO 62, DIN 53495



## Minimum Required Strength (MRS):

Polyethylene pipes and fittings materials are evaluated on the basis of their Minimum Required Strength.

When PE 100 pipes are hydro-statically tested at 20°C, ISO 1167 specify a Minimum Required Strength at 50 years of 10 Mpa (100bar) - MRS100.

When PE 80 pipes are hydro-statically tested at 20°C, ISO 1167 specify a Minimum Required Strength at 50 years of 8 Mpa (80bar) - MRS80.

The MRS value for PE 100 compound is 10MPa. PE 100 pipe has enhanced toughness, higher permissible design strength and improved resistance to rapid crack propagation in addition to benefits in efficiency and economy. This allows the design engineers to use PE 100 pipes at substantially higher operating pressures than PE 80 pipes with equivalent SDR rating i.e. allows PE 100 pipes to be produced with thinner walls than PE 80 pipes of equivalent SDR rating.

# Automated Quality Control System

## Introduction:

The production of plastic pipes is largely determined by the high demands on quality control, economic efficiency and productivity. These demands can be met only by up-to-date automation concepts.

The Automated Quality Control product line solves almost all measuring, automation and documentation tasks for single-layer pipes while offering customized process solutions for very specific pipes. Of particular interest is the easy operation of the complete system. This includes, above all, the easy operation of the software, the temperature-independent measuring principle and the automatic centring of the measuring mechanics.

Automated Quality Control system with its electronically rotating sensors covers a broad product spectrum. Process-oriented automatically centring measuring mechanics combined with gravimetry, thermal centring and other modules provide an affordable complete solution for the automation of pipe extrusion lines. Designed especially for the gas pipe and pressure pipe production, the portable is designed for a fast direct measurement independent of pipe temperatures. It is able to carry out a 100 % wall thickness measurement of pipe diameters.

## Benefits:

- ▶ Comprehensive product information (wall thickness, diameters, eccentricity, ovality)
- ▶ Absolute measurement Automatic centring
- ▶ Independent of pipe temperatures
- ▶ Maintenance-free
- ▶ Material savings of 5% or more through s-min control or thin points control, improved centring process and a systematic start-up of the extrusion line
- ▶ Documentation for submission to the customer
- ▶ Proven control principles
- ▶ Easy connection to extruder control
- ▶ Easy to use, thus low training need



# HDPE System

## Design Stress & Safety Factor:

Safety factors are taken into account for handling conditions, service conditions and other circumstances not directly considered in the design. In terms of ISO 4427 the minimum safety factor is 1.25. This factor, when applied to the Minimum

Required Strength (MRS), for the particular material classification (e.g. PE 80, PE 100), gives the maximum allowable hydrostatic design stress for the designated material.

Designation of Material	MRS at 50 years & 20°C (Mpa)	Hydrostatic Design Stress (Mpa)
PE 100	10	8
PE 80	8	6.4

Formula:  $\frac{MRS}{c}$ ,  $c=1.25$



## Pipe SDR & Pressure Relationships:

SDR is the standard dimensional ratio, it is the ratio between the O.D. (Outside Diameter) of the pipe & the wall thickness. E.g.:

As per ISO 4427, the SDR of 110mm 10 bar rated PE 100 pipe is  $110/6.6 = 16.66$  i.e. SDR 17

As per ISO 4427, the SDR of 110mm 16 bar rated PE 100 pipe is  $110/10 = 11$  i.e. SDR 11

As per ISO 4427, the SDR of 110mm 20 bar rated PE 100 pipe is  $110/12.3 = 8.94$  i.e. SDR 9

Material	Design Stress (Mpa)	Nominal Pressure (PN)								
		4	5	6	8	10	12.5	16	20	25
PE 100	8.0	SDR 41	SDR 33	SDR 26	SDR 21	SDR 17	SDR 13.6	SDR 11	SDR 9	SDR 7.4
PE 80	6.4	SDR 33	SDR 26	SDR 21	SDR 17	SDR 13.6	SDR 11	SDR 9	SDR 7.4	SDR 6

# HDPE System

## Pressure Reduction Co-Efficient for PE 100 as Per ISO 4427:2007:

When a HDPE piping system is operated at a continuous constant temperature higher than 20°C, a pressure reduction co-efficient as given in the below tables are applicable.

From the below table, Pressure rating of different SDRs at various level of temperature can be determined, therefore pipe selection can be made early at the design stage.

PE 100							
Temperature °C	20	25	30	35	40	45	50
Pressure Reduction Co-efficient	1	0.93	0.87	0.80	0.74	0.675	0.61
SDR	Pressure in Bar						
7.4	25.0	23.3	21.8	20.0	18.5	16.87	15.25
9.0	20.0	18.6	17.4	16.0	14.8	13.50	12.20
11.0	16.0	14.9	13.9	12.8	11.8	10.80	9.76
13.6	12.5	11.6	10.9	10.0	9.3	8.40	7.60
17.0	10.0	9.3	8.7	8.0	7.4	6.80	6.10
21.0	8.0	7.4	7.0	6.4	5.9	5.40	4.90
26.0	6.0	5.6	5.2	4.8	4.4	4.00	3.70
33.0	5.0	4.7	4.4	4.0	3.7	3.40	3.00
41.0	4.0	3.7	3.5	3.2	3.0	2.70	2.40

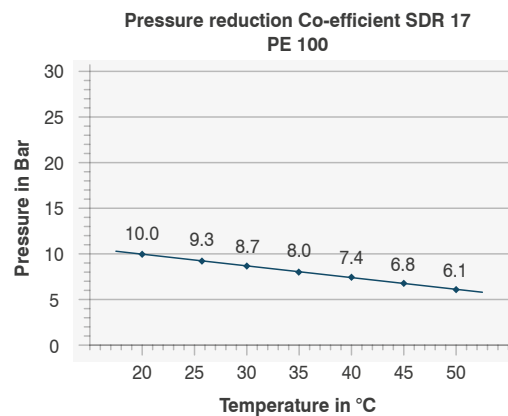
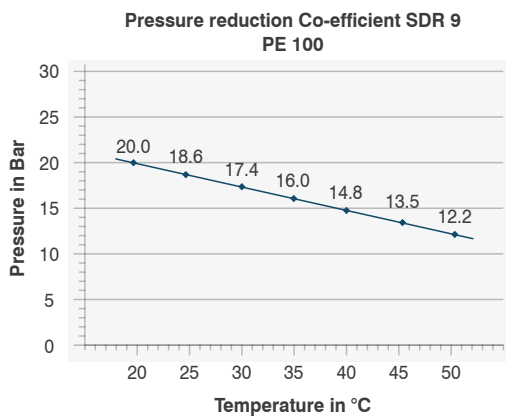
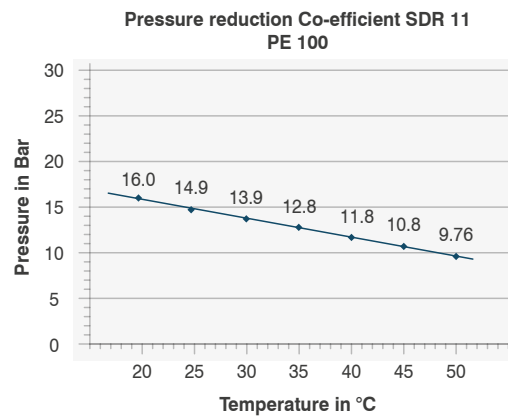
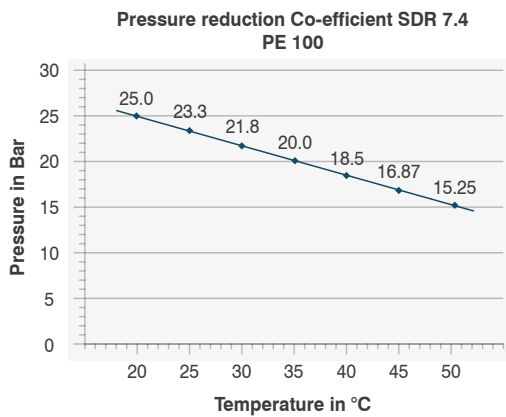

# HDPE System

## Manufacturing Process:

SHIELD manufactures Polyethylene Pipes and Fittings with a combination of advanced technologies, tested and proven materials and efficient factory production techniques. The facilities are equipped with state of the art technologies, operated by a team of highly skilled personnel.

The manufacturing facilities are being inspected on an ongoing basis, and passes both scheduled and unscheduled inspections. Strict Quality Control procedures are conducted on a routine basis throughout the entire production cycle from the inspection of the raw materials to the storage of the finished goods to ensure products compliance with the relevant standards.

SHIELD's high-tech laboratory consists of modern calibrated machines to meet stringent quality standards.



SHIELD HDPE PIPE ISO 4427 PE100 125x11.4mm SDR11 PN16 07 MAY 17 118 0 400 PN11 01 11 MADE IN DE

# HDPE System

## Quality Control:



SHIELD facilities are equipped with latest tools and technologies which can handle all the related processes of strict quality control which are routinely conducted throughout the production process from the inspection of raw materials to the finished goods. Rigorous quality control procedures are carried throughout the manufacturing process from bringing in the raw material to the delivery & storage of finish products.

Apart from the manufacturing process, SHIELD also provides on-site engineering, technical and installation assistance.

## Quality Control Procedure:

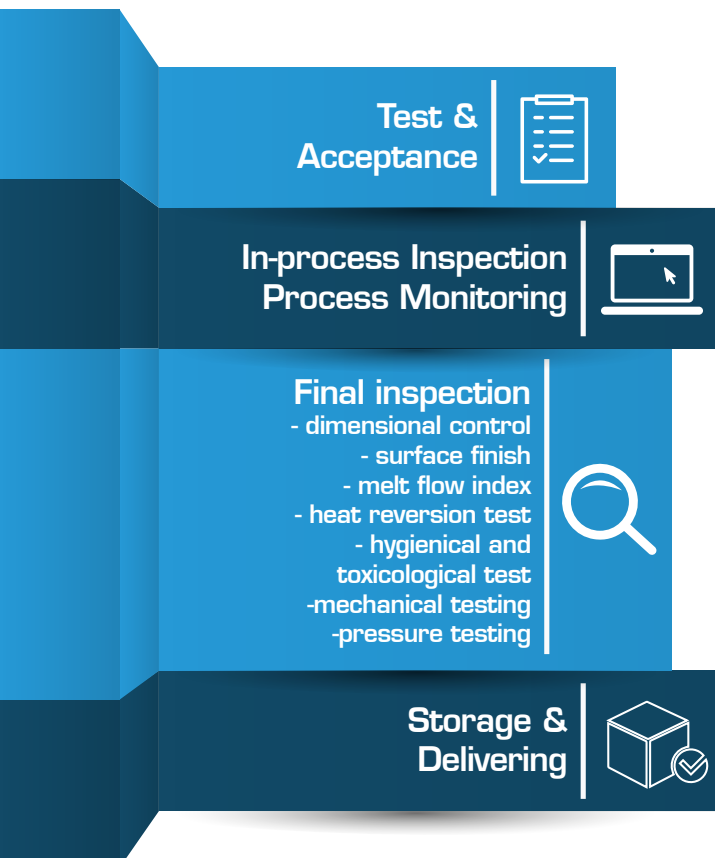

- 1 Raw Materials
- 2 Production
- 3 In-process Inspection
- 4 Final Inspection
- 5 Storage, Packaging & Dispatch



## HDPE Pipe (PE100) Technical Data as per ISO 4427:

Pipe Sizes & Corresponding Wall Thickness at Different SDRs is as follows:

SD-PEPW

SDR	Outside Diameter		SDR 41		SDR 33		SDR 26		SDR 21		SDR 17		SDR 13.6		SDR 11		SDR 9		SDR 7.4	
			PN4		PN5		PN6		PN8		PN10		PN12.5		PN16		PN20		PN25	
			Wall Thickness		Wall Thickness		Wall Thickness		Wall Thickness		Wall Thickness		Wall Thickness		Wall Thickness		Wall Thickness		Wall Thickness	
Nominal Size L mm	Min	Max	Min	Max	Min	Max	Min	Max	Min	Max	Min	Max	Min	Max	Min	Max	Min	Max	Min	Max
	16	16	16.3	-	-	-	-	-	-	-	-	-	-	-	-	-	-	2.0	2.3	2.3
20	20	20.3	-	-	-	-	-	-	-	-	-	-	-	-	2.0	2.3	2.3	2.7	3.0	3.4
25	25	25.3	-	-	-	-	-	-	-	-	-	-	2.0	2.3	2.3	2.7	3.0	3.4	3.5	4.0
32	32	32.3	-	-	-	-	-	-	-	-	2.0	2.3	2.4	2.8	3.0	3.4	3.6	4.1	4.4	5.0
40	40	40.4	-	-	-	-	-	-	2.0	2.3	2.4	2.8	3.0	3.5	3.7	4.2	4.5	5.1	5.5	6.2
50	50	50.4	-	-	-	-	2.0	2.3	2.4	2.8	3.0	3.4	3.7	4.2	4.6	5.2	5.6	6.3	6.9	7.7
63	63	63.4	-	-	-	-	2.5	2.9	3.0	3.4	3.8	4.3	4.7	5.3	5.8	6.5	7.1	8.0	8.6	9.6
75	75	75.5	-	-	-	-	2.9	3.3	3.6	4.1	4.5	5.1	5.6	6.3	6.8	7.6	8.4	9.4	10.3	11.5
90	90	90.6	-	-	-	-	3.5	4.0	4.3	4.9	5.4	6.1	6.7	7.5	8.2	9.2	10.1	11.3	12.3	13.7
110	110	110.7	-	-	-	-	4.2	4.8	5.3	6.0	6.6	7.4	8.1	9.1	10.0	11.1	12.3	13.7	15.1	16.8
125	125	125.8	-	-	-	-	4.8	5.4	6.0	6.7	7.4	8.3	9.2	10.3	11.4	12.7	14.0	15.6	17.1	19.0
140	140	140.9	-	-	-	-	5.4	6.1	6.7	7.5	8.3	9.3	10.3	11.5	12.7	14.1	15.7	17.4	19.2	21.3
160	160	161.0	-	-	-	-	6.2	7.0	7.7	8.6	9.5	10.6	11.8	13.1	14.6	16.2	17.9	19.8	21.9	24.2
180	180	181.1	-	-	-	-	6.9	7.7	8.6	9.6	10.7	11.9	13.3	14.8	16.4	18.2	20.1	22.3	24.6	27.2
200	200	201.2	-	-	-	-	7.7	8.6	9.6	10.7	11.9	13.2	14.7	16.3	18.2	20.2	22.4	24.8	27.4	30.3
225	225	226.4	-	-	-	-	8.6	9.6	10.8	12.0	13.4	14.9	16.6	18.4	20.5	22.7	25.2	27.9	30.8	34.0
250	250	251.5	-	-	-	-	9.6	10.7	11.9	13.2	14.8	16.4	18.4	20.4	22.7	25.1	27.9	30.8	34.2	37.8
280	280	281.7	-	-	-	-	10.7	11.9	13.4	14.9	16.6	18.4	20.6	22.8	25.4	28.1	31.3	34.6	38.3	42.3
315	315	316.9	7.7	8.6	9.7	10.8	12.1	13.5	15.0	16.6	18.7	20.7	23.2	25.7	28.6	31.6	35.2	38.9	43.1	47.6
355	355	357.2	8.7	9.7	10.9	12.1	13.6	15.1	16.9	18.7	21.1	23.4	26.1	28.9	32.2	35.6	39.7	43.8	48.5	53.5
400	400	402.4	9.8	10.9	12.3	13.7	15.3	17.0	19.1	21.2	23.7	26.2	29.4	32.5	36.3	40.1	44.7	49.3	54.7	60.3
450	450	452.7	11.0	12.2	13.8	15.3	17.2	19.1	21.5	23.8	26.7	29.5	33.1	36.6	40.9	45.1	50.3	55.5	61.5	67.8
500	500	503.0	12.3	13.7	15.3	17	19.1	21.2	23.9	26.4	29.7	32.8	36.8	40.6	45.4	50.1	55.8	61.5	68.2	75.4
560	560	563.4	13.7	15.2	17.2	19.1	21.4	23.7	26.7	29.5	34.3	37.8	41.2	46.1	50.8	56.0	62.5	68.9	-	-
630	630	633.8	15.4	17.1	19.3	21.4	24.1	26.7	30.0	33.1	37.4	41.3	46.3	51.1	57.2	63.1	70.3	77.5	-	-
710	710	716.4	17.4	19.3	21.8	24.1	27.2	30.1	33.9	37.4	42.1	46.5	52.2	57.6	64.5	71.1	79.3	87.4	-	-
800	800	807.2	19.6	21.7	24.5	27.1	30.6	33.8	38.1	42.1	47.4	52.3	58.8	64.8	72.6	80.0	89.3	98.4	-	-
900	900	908.1	22.0	24.3	27.6	30.5	34.4	38.3	42.9	47.3	53.3	58.8	66.2	73.0	81.7	90.0	-	-	-	-
1000	1000	1009.0	24.5	27.1	30.6	33.5	38.2	42.2	47.7	52.6	59.3	65.4	72.5	79.9	90.2	99.4	-	-	-	-
1200	1200	1210.8	29.4	32.5	36.7	40.5	45.9	50.6	57.2	63.1	67.9	74.8	88.2	97.2	-	-	-	-	-	-
1400	1400	1412.6	34.3	37.9	42.9	47.3	53.5	59.0	66.7	73.5	82.4	90.8	102.9	113.3	-	-	-	-	-	-
1600	1600	1614.4	39.2	43.3	49	54	61.2	67.5	76.2	84.0	94.1	103.7	117.6	129.5	-	-	-	-	-	-
1800	1800	1816.2	43.8	48.3	54.5	60.1	69.1	76.2	85.7	94.4	105.9	116.6	-	-	-	-	-	-	-	-
2000	2000	2018.0	48.8	53.8	60.6	66.8	76.9	84.7	95.2	104.9	117.6	129.5	-	-	-	-	-	-	-	-

NOTE:

- Refer to FM & WRAS certificates for more information.
- PN values are based on C=1.25.
- Tolerances in accordance with grade V of ISO 11922-1:1997.
- The calculated value of e-min (ISO 4085:1998) is rounded up to the nearest value of either 2.0, 2.3 or 3.0. This is to satisfy certain national requirements.
- For practical reasons a wall thickness of 3.00 mm is recommended for Electro-Fusion jointing and lining applications.
- Upto 110mm Shield pipes are also available in coils.
- Please contact us for more information.

# Water Line

## MDPE Pipe (PE80) Technical Data as per ISO 4427:

Pipe Sizes & Corresponding Wall Thickness at Different SDRs is as follows:

SD-PEPW

SDR	Outside Diameter		SDR 41		SDR 33		SDR 26		SDR 21		SDR 17		SDR 13.6		SDR 11		SDR 9		SDR 7.4	
			PN 3.2		PN 4		PN 5		PN 6		PN 8		PN 10		PN 12.5		PN 16		PN 20	
			Wall Thickness		Wall Thickness		Wall Thickness		Wall Thickness		Wall Thickness		Wall Thickness		Wall Thickness		Wall Thickness		Wall Thickness	
Nominal Size L	Min	Max	Min	Max	Min	Max	Min	Max	Min	Max	Min	Max	Min	Max	Min	Max	Min	Max	Min	Max
mm	mm	mm	mm	mm	mm	mm	mm	mm	mm	mm	mm	mm	mm	mm	mm	mm	mm	mm	mm	mm
16	16	16.3	-	-	-	-	-	-	-	-	-	-	-	-	-	-	2.0	2.3	2.3	2.7
20	20	20.3	-	-	-	-	-	-	-	-	-	-	-	-	2.0	2.3	2.3	2.7	3.0	3.4
25	25	25.3	-	-	-	-	-	-	-	-	-	-	2.0	2.3	2.3	2.7	3.0	3.4	2.5	4.0
32	32	32.3	-	-	-	-	-	-	-	-	2.0	2.3	2.4	2.8	3.0	3.4	3.6	4.1	4.4	5.0
40	40	40.4	-	-	-	-	-	-	2.0	2.3	2.4	2.8	3.0	3.5	3.7	4.2	4.5	5.1	5.5	6.2
50	50	50.4	-	-	-	-	2.0	2.3	2.4	2.8	3.0	3.4	3.7	4.2	4.6	5.2	5.6	6.3	6.9	7.7
63	63	63.4	-	-	-	-	2.5	2.9	3.0	3.4	3.8	4.3	4.7	5.3	5.8	6.5	7.1	8.0	8.6	9.6
75	75	75.5	-	-	-	-	2.9	3.3	3.6	4.1	4.5	5.1	5.6	6.3	6.8	7.6	8.4	9.4	10.3	11.5
90	90	90.6	-	-	-	-	3.5	4.0	3.5	4.0	5.4	6.1	6.7	7.5	8.2	9.2	10.1	11.3	12.3	13.7
110	110	110.7	-	-	-	-	4.2	4.8	5.3	6.0	6.6	7.4	8.1	9.1	10.0	11.1	12.3	13.7	15.1	16.8
125	125	125.8	-	-	-	-	4.8	5.4	6.0	6.7	7.4	8.3	9.2	10.3	11.4	12.7	14.0	15.6	17.1	19.0
140	140	140.9	-	-	-	-	5.4	6.1	6.7	7.5	8.3	9.3	10.3	11.5	12.7	14.1	15.7	17.4	19.2	21.3
160	160	161.0	-	-	-	-	6.2	7.0	7.7	8.6	9.5	10.6	11.8	13.1	14.6	16.2	17.9	19.8	21.9	24.2
180	180	181.1	-	-	-	-	6.9	7.7	8.6	9.6	10.7	11.9	13.3	14.8	16.4	18.2	20.1	22.3	24.6	27.2
200	200	201.2	-	-	-	-	7.7	8.6	9.6	10.7	11.9	13.2	14.7	16.3	18.2	20.2	22.4	24.8	27.4	30.3
225	225	226.4	-	-	-	-	8.6	9.6	10.8	12.0	13.4	14.9	16.6	18.4	20.5	22.7	25.2	27.9	30.8	34.0
250	250	251.5	-	-	-	-	9.6	10.7	11.9	13.2	14.8	16.4	18.4	20.4	22.7	25.1	27.9	30.8	34.2	37.8
280	280	281.7	-	-	-	-	10.7	11.9	13.4	14.9	16.6	18.4	20.6	22.8	25.4	28.1	31.3	34.6	38.3	42.3
315	315	316.9	7.7	8.6	9.7	10.8	12.1	13.5	15.0	16.6	18.7	20.7	23.2	25.7	28.6	31.6	35.2	38.9	43.1	47.6
355	355	357.2	8.7	9.7	10.9	12.1	13.6	15.1	16.9	18.7	21.1	23.4	26.1	28.9	32.2	35.6	39.7	43.8	48.5	53.5
400	400	402.4	9.8	10.9	12.3	13.7	15.3	17.0	19.1	21.2	23.7	26.2	29.4	32.5	36.3	40.1	44.7	49.3	54.7	60.3
450	450	452.7	11.0	12.2	13.8	15.3	17.2	19.1	21.5	23.8	26.7	29.5	33.1	36.6	40.9	45.1	50.3	55.5	61.5	67.8
500	500	503.0	12.3	13.7	15.3	17.0	19.1	21.2	23.9	26.4	29.7	32.8	36.8	40.6	45.4	50.1	55.8	61.5	68.2	75.4
560	560	563.4	13.7	15.2	17.2	19.1	21.4	23.7	26.7	29.5	33.2	36.7	41.2	45.5	50.8	56.0	62.5	68.9	-	-
630	630	633.8	15.4	17.1	19.3	21.4	24.1	26.7	30.0	33.1	37.4	41.3	46.3	51.1	57.2	63.1	70.3	77.5	-	-
710	710	716.4	17.4	19.3	21.8	24.1	27.2	30.1	33.9	37.4	42.1	46.5	52.2	57.6	64.5	71.1	79.3	87.4	-	-
800	800	807.2	19.6	21.7	24.5	27.1	30.6	33.8	38.1	42.1	47.4	52.3	58.8	64.8	72.6	80.0	89.3	98.4	-	-
900	900	908.1	22.0	24.3	27.6	30.5	34.4	38.3	42.9	47.3	53.3	58.8	66.2	73.0	81.7	90.0	-	-	-	-
1000	1000	1009.0	24.5	27.1	30.6	33.5	38.2	42.2	47.7	52.6	59.3	65.4	72.5	79.9	90.2	99.4	-	-	-	-
1200	1200	1210.8	29.4	32.5	36.7	40.5	45.9	50.6	57.2	63.1	67.9	74.8	88.2	97.2	-	-	-	-	-	-
1400	1400	1412.6	34.3	37.9	42.9	47.3	53.5	59.0	66.7	73.5	82.4	90.8	102.9	113.3	-	-	-	-	-	-
1600	1600	1614.4	39.2	43.3	49.0	54.0	61.2	67.5	76.2	84.0	94.1	103.7	117.6	129.5	-	-	-	-	-	-
1800	1800	1816.2	43.8	48.3	54.5	60.1	69.1	76.2	85.7	94.4	105.9	116.6	-	-	-	-	-	-	-	-
2000	2000	2018.0	48.8	53.8	60.6	66.8	76.9	84.7	95.2	104.9	117.6	129.5	-	-	-	-	-	-	-	-

NOTE:

- Refer to FM & WRAS certificates for more information.
- PN values are based on C=1.25.
- Tolerances in accordance with grade V of ISO 11922-1:1997.
- The calculated value of e-min (ISO 4085:1998) is rounded up to the nearest value of either 2.0, 2.3 or 3.0. This is to satisfy certain national requirements.
- For practical reasons a wall thickness of 3.00 mm is recommended for Electro-Fusion jointing and lining applications.
- Upto 110mm Shield pipes are also available in coils.
- Please contact us for more information.

# Water Line

## Pipe Selection of Bore Size PE80 as per ISO 4427:

Design engineers choose pipe selection of bore size Shield PE80 is as follows:

Nominal Size mm	PE 80		
	SDR13.6 PN10	SDR9 PN16	SDR7 PN20
50	42.6	38.8	36.2
63	53.6	48.8	45.8
75	63.8	58.2	54.4
90	76.6	69.8	65.4
110	93.8	85.4	79.8
125	106.6	97	90.8
140	119.4	108.6	101.6
160	136.4	124.2	116.2
180	153.4	139.8	130.8
200	170.6	155.2	145.2
225	191.8	174.6	163.4
250	213.2	194.2	181.6
280	238.8	217.4	203.4
315	268.6	244.6	228.8



## Pressure reduction co-efficient for PE80 as per ISO 4427: 2007

PE80					
Temp (Deg C)	20	25	30	35	40
Pressure Reduction Co-efficient	1	0.93	0.87	0.8	0.74
SDR	Pressure in Bar				
6	25	23.3	21.8	20	18.5
7.4	20	18.6	17.4	16	14.8
9	16	14.9	13.9	12.8	11.8
11	12.5	11.6	10.9	10	9.3
13.6	10	9.3	8.7	8	7.4
17	8	7.4	7	6.4	5.9
21	6	5.6	5.2	4.8	4.4
26	5	4.7	4.4	4	3.7
33	4	3.7	3.5	3.2	3
41	3.2	3	2.8	2.6	2.4

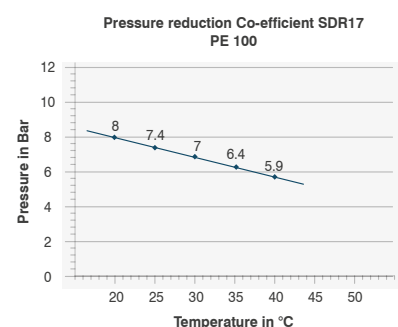
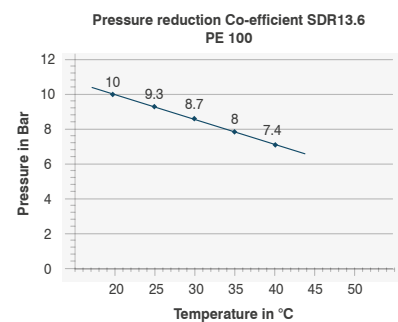
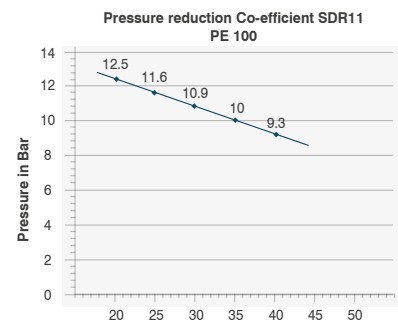

# Water Line

## HDPE Pipe Technical Data as per ANSI/AWWA C906:

Pipe Sizes & Corresponding Wall Thickness at Different DRs is as follows:

SD-PEPW

DR	Outside Diameter		DR 11		DR 9		DR 7.3		DR 7	
			PC200		PC250		PC317		PC335	
			13.79		17.23		21.85		23.09	
			Wall Thickness		Wall Thickness		Wall Thickness		Wall Thickness	
L	Min	Max	Min	Max	Min	Max	Min	Max	Min	Max
Inch	Inch	Inch	Inch	Inch	Inch	Inch	Inch	Inch	Inch	Inch
4	4.480	4.520	0.409	0.458	0.500	0.560	0.625	0.700	0.643	0.720
6	6.600	6.660	0.602	0.674	0.736	0.825	0.920	1.031	0.946	1.060
8	8.590	8.660	0.784	0.878	0.958	1.073	1.198	1.342	1.228	1.376
10	10.700	10.800	0.977	1.094	1.194	1.337	1.473	1.650	1.536	1.720
12	12.690	12.810	1.159	1.298	1.417	1.587	1.747	1.957	1.821	2.039
14	13.940	14.060	1.273	1.426	1.556	1.743	1.918	2.148	2.000	2.240
16	15.930	16.071	1.455	1.630	1.778	1.992	2.192	2.455	2.286	2.560
18	17.920	18.081	1.636	1.832	2.000	2.240	2.466	2.762	2.571	2.879
20	19.910	20.090	1.818	2.036	2.222	2.489	2.740	3.069	2.857	3.200
22	21.900	22.099	2.000	2.240	2.444	2.737	3.014	3.376	3.143	3.520
24	23.890	24.108	2.182	2.444	2.667	2.987	3.288	3.683	3.429	3.841
26	25.880	26.117	2.364	2.648	2.889	3.236	3.562	3.989	3.714	4.160
28	27.870	28.126	2.545	2.850	3.111	3.484	3.836	4.296	-	-
30	29.860	30.135	2.727	3.054	3.333	3.733	-	-	-	-
32	31.860	32.144	2.909	3.258	3.556	3.983	-	-	-	-
34	33.850	34.153	3.091	3.462	3.778	4.231	-	-	-	-
36	35.840	36.162	3.273	3.666	-	-	-	-	-	-
42	41.810	42.189	3.818	4.276	-	-	-	-	-	-

**NOTE:**

- ▶ Refer to UL, FM & WRAS certificates for more information.
- ▶ Please contact us for more information.

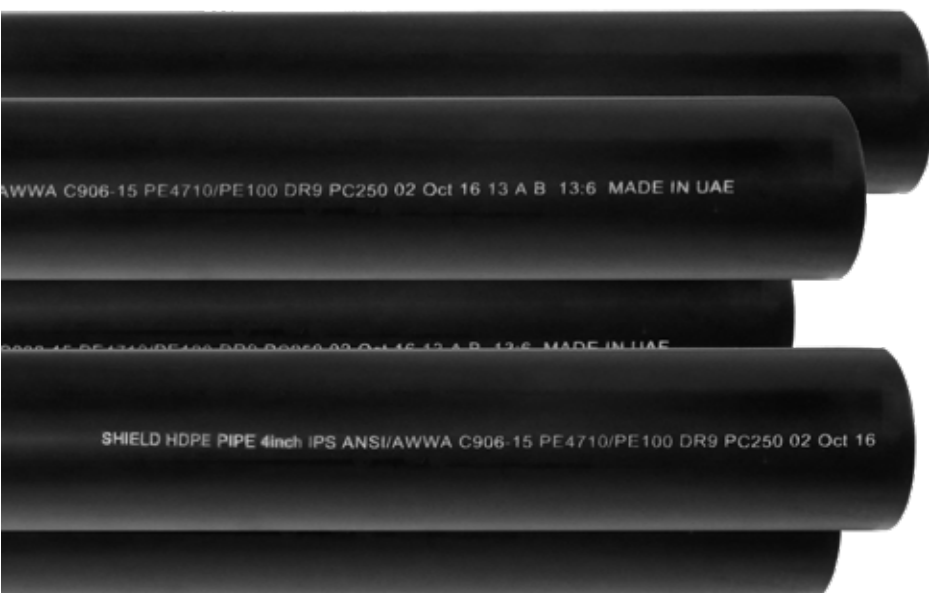

# Water Line

## HDPE Pipe Selection (Bore Size):

Design Engineers choose SHIELD PE 100 piping system, as the system provides larger bore size because of its lower wall thickness. Moreover, at the same working pressure, designers can opt for lower SDR level pipe than in PE 80 piping system.

Bore Size of PE 100 as per **ISO 4427 & AWWA C906**:

### SD-PEPW

Pipe Size mm	ISO 4427 - PE 100				Pipe Size Inch	AWWA C906 - PE 100			
	SDR 17 PN10 mm	SDR 11 PN16 mm	SDR 9 PN20 mm	SDR 7.4 PN25 mm		DR11 PC200 Inch	DR 9 PC250 Inch	DR 7.3 PC317 Inch	DR 7 PC335 Inch
50	44.0	40.8	38.8	36.2	4	3.66	2.66	1.41	0.13
63	55.4	51.4	48.8	45.8	6	5.40	3.92	2.08	0.19
75	66.0	61.4	58.2	54.4	8	7.02	5.11	2.71	0.25
90	79.2	73.6	69.8	65.4	10	8.75	6.36	3.41	0.34
110	96.8	90.0	85.4	79.8	12	10.37	7.54	4.04	0.40
125	110.2	102.2	97.0	90.8	14	11.39	8.28	4.45	0.45
140	123.4	114.6	108.6	101.6	16	13.02	9.46	5.08	0.51
160	141.0	130.8	124.2	116.2	18	14.65	10.65	5.72	0.57
180	158.6	147.2	139.8	130.8	20	16.27	11.83	6.35	0.64
200	176.2	163.6	155.2	145.2	22	17.90	13.01	6.98	0.70
225	198.2	184.0	174.6	163.4	24	19.53	14.19	7.62	0.76
250	220.4	204.6	194.2	181.6	26	21.15	15.37	8.25	0.82
280	246.8	229.2	217.4	203.4	-	-	-	-	-
315	277.6	257.8	244.6	228.8	-	-	-	-	-

NOTE: For installation instructions please refer to our technical guidelines.



# Gas Line

## PE Pipe Technical Data as per ISO 4437 & BS EN 1555:

SHIELD Polyethylene is the right choice for your Gas application due to its characteristics such as strength, flexibility, inertness, quality, light weight and ease of maintenance and installation. SHIELD PE pipes are maintenance free with a design life of over 50 years under normal operating conditions.

SHIELD manufactures PE pipes for GAS service as per ISO 4437 & BS EN 1555 standards which undergo rigorous quality checks throughout the entire production process to ensure their reliability and effectiveness for gas transportation. The preferred series of pipes are SDR 11 and SDR 17 for gas applications.

Pipes are available in coils of 50 and 100 meters for sizes up to 160mm in order to reduce the number of joints to make a cost effective choice for contractors and clients. Pipes are also available in straight lengths of 6 or 12 meters. The jointing can be done by Butt-Fusion or Electro-Fusion methods, providing a completely homogeneous leak free system.

## Pipe Sizes & Corresponding Wall Thickness as per ISO 4437 & BS EN 1555:

SD-PEPG

Nominal Outside Diameter	PE 100 - MRS 10 MPa		PE 80 - MRS 8 MPa	
	SDR 17 PN 6.25	SDR 11 PN 10	SDR 17 PN 5	SDR 11 PN 8
	Wall Thickness		Wall Thickness	
mm	mm		mm	
20	-	2.3 - 2.7	-	2.3 - 2.7
25	-	2.3 - 2.7	-	2.3 - 2.7
32	2.3 - 2.7	3.0 - 3.5	2.3 - 2.7	3.0 - 3.5
40	2.4 - 2.8	3.7 - 4.2	2.4 - 2.8	3.7 - 4.2
50	3.0 - 3.5	4.6 - 5.2	3.0 - 3.5	4.6 - 5.2
63	3.8 - 4.3	5.8 - 6.5	3.8 - 4.3	5.8 - 6.5
75	4.5 - 5.1	6.8 - 7.6	4.5 - 5.1	6.8 - 7.6
90	5.4 - 6.1	8.2 - 9.2	5.4 - 6.1	8.2 - 9.2
110	6.6 - 7.4	10.0 - 11.1	6.6 - 7.4	10.0 - 11.1
125	7.4 - 8.3	11.4 - 12.7	7.4 - 8.3	11.4 - 12.7
140	8.3 - 9.3	12.7 - 14.1	8.3 - 9.3	12.7 - 14.1
160	9.5 - 10.6	14.6 - 16.2	9.5 - 10.6	14.6 - 16.2
180	10.7 - 11.9	16.4 - 18.2	10.7 - 11.9	16.4 - 18.2
200	11.9 - 13.2	18.2 - 20.2	11.9 - 13.2	18.2 - 20.2
225	13.4 - 14.9	20.5 - 22.7	13.4 - 14.9	20.5 - 22.7
250	14.8 - 16.4	22.7 - 25.1	14.8 - 16.4	22.7 - 25.1
280	16.6 - 18.4	25.4 - 28.1	16.6 - 18.4	25.4 - 28.1
315	18.7 - 20.7	28.6 - 31.6	18.7 - 20.7	28.6 - 31.6
355	21.1 - 23.4	32.2 - 35.6	21.1 - 23.4	32.2 - 35.6
400	23.7 - 26.2	36.4 - 40.1	23.7 - 26.2	36.4 - 40.1
450	26.7 - 29.5	40.9 - 45.1	26.7 - 29.5	40.9 - 45.1
500	29.7 - 32.8	45.5 - 50.1	29.7 - 32.8	45.5 - 50.1
560	33.2 - 36.7	50.9 - 56.1	33.2 - 36.7	50.9 - 56.1
630	37.4 - 41.3	57.3 - 63.2	37.4 - 41.3	57.3 - 63.2

NOTE:

- ▶ SDR 11 & SDR 17 are the series commonly used for gas application.
- ▶ Other SDRs are also available upon request.
- ▶ Outer diameter & Wall thickness is according to ISO 11922-1.
- ▶ For applications above 20 Deg C – suitable de-rating factors apply.
- ▶ PE 100 Minimum Required Strength (MRS) is 10 Mpa.
- ▶ PE 80 Minimum Required Strength (MRS) is 8 Mpa.
- ▶ All dimensions for BS EN 1555 are same as ISO 4437 except for 20 & 25 mm (min 3mm Wall Thickness for SDR 11).
- ▶ Please contact us for more information.



# Fire Line

## HDPE Pipe Technical Data:

SHIELD HDPE pipes are manufactured complying to ISO 4427 (metric) and ANSI/AWWA C906 (inch) standards. SHIELD produce and supply moulded and segmented fittings as per ISO and AWWA standards under stringent quality control. Our pipes and fittings are tested at each stage of production to comply with quality and standards.

### HDPE Pipe Dimensions as per ISO 4427:

#### SD-PEPF

PE 100 mm	SDR11 PN16		SDR9 PN20		SDR7.4 PN25	
	e-min mm	e-max mm	e-min mm	e-max mm	e-min mm	e-max mm
50	4.6	5.2	5.6	6.3	6.9	7.7
63	5.8	6.5	7.1	8.0	8.6	9.6
75	6.8	7.6	8.4	9.4	10.3	11.5
90	8.2	9.2	10.1	11.3	12.3	13.7
110	10.0	11.1	12.3	13.7	15.1	16.8
125	11.4	12.7	14.0	15.6	17.1	19.0
140	12.7	14.1	15.7	17.4	19.2	21.3
160	14.6	16.2	17.9	19.8	21.9	24.2
180	16.4	18.2	20.1	22.3	24.6	27.2
200	18.2	20.2	22.4	24.8	27.4	30.3
225	20.5	22.7	25.2	27.9	30.8	34.0
250	22.7	25.1	27.9	30.8	34.2	37.8
280	25.4	28.1	31.3	34.6	38.3	42.3
315	28.6	31.6	35.2	38.9	43.1	47.6
355	32.2	35.6	39.7	43.8	48.5	53.5
400	36.3	40.1	44.7	49.3	54.7	60.3
450	40.9	45.1	50.3	55.5	61.5	67.8
500	45.4	50.1	55.8	61.5	-	-
560	50.8	56.0	-	-	-	-
630	57.2	63.1	-	-	-	-

### Pipe Dimensions in ANSI/AWWA C906:

#### SD-PEPF

Nominal Size L Inch	Outside Diameter		DR 11 PC200		DR 9 PC250		DR 7.3 PC317		DR 7 PC335	
	Min Inch	Max Inch	Wall Thickness		Wall Thickness		Wall Thickness		Wall Thickness	
			Min Inch	Max Inch	Min Inch	Max Inch	Min Inch	Max Inch	Min Inch	Max Inch
4	4.480	4.520	0.409	0.458	0.500	0.560	0.625	0.700	0.643	0.720
6	6.600	6.660	0.602	0.674	0.736	0.825	0.920	1.031	0.946	1.060
8	8.590	8.660	0.784	0.878	0.958	1.073	1.198	1.342	1.228	1.376
10	10.700	10.800	0.977	1.094	1.194	1.337	1.473	1.650	1.536	1.720
12	12.690	12.810	1.159	1.298	1.417	1.587	1.747	1.957	1.821	2.039
14	13.940	14.060	1.273	1.426	1.556	1.743	1.918	2.148	2.000	2.240
16	15.930	16.071	1.455	1.630	1.778	1.992	2.192	2.455	2.286	2.560
18	17.920	18.081	1.636	1.832	2.000	2.240	2.466	2.762	2.571	2.879
20	19.910	20.090	1.818	2.036	2.222	2.489	2.740	3.069	2.857	3.200
22	21.900	22.099	2.000	2.240	2.444	2.737	3.014	3.376	3.143	3.520
24	23.890	24.108	2.182	2.444	2.667	2.987	3.288	3.683	3.429	3.841
26	25.880	26.117	2.364	2.648	2.889	3.236	3.562	3.989	3.714	4.160

NOTE:

- ▶ For installation instructions please refer to our technical guidelines.
- ▶ Refer to UL and FM certificates for more details.
- ▶ Please contact us for more information.

## Hydrant Installation:

Where local soil does not provide the needed support for the HDPE pipe, heavy thrust blocks or dense concrete mixes can sink. When a large thrust block sinks, it creates excessive bending moment and failure which must be avoided. Where good local soil conditions exist, no thrust block or special bedding is required. If local soil conditions support the use of geo-textile fabrics or stabilized soils offer another way to provide good proper support to pipe and fittings to prevent excessive bending should be used.

**UNDERGROUND  
HDPE FIRE LINE  
CONNECTED TO  
ABOVE GROUND  
STEEL PIPE**



# Drainage Line

## HDPE Pipe Technical Data as per BS EN 1519-1:

SHIELD also provides an effective and economic alternative to cast iron and other traditional systems for drainage applications. The SHIELD HDPE drainage system is a total solution for all types of drainage requirements, soil and waste include above and below ground, and chemical waste applications. The exceptional performance is the result of versatile characteristics of SHIELD HDPE, which make the system fit for long term solution as compared to cast iron and other traditional systems. Its Corrosion resistance and ability to withstand in different temperature makes it suitable to use in chemical and greasy kitchen waste applications.

What makes SHIELD HDPE Piping System a great alternative solution?

- ✓ Corrosion & Abrasion resistance
- ✓ Chemical resistance
- ✓ Impact resistance
- ✓ Heat Resistance
- ✓ Low weight, flexible and Easy to install
- ✓ Ideal for prefabrication and recyclable.

### Areas of application

SHIELD HDPE Drainage Pipe is suitable for Laboratories, Factories, Hotels and Domestic/ Commercial/Industrial buildings.

### Standards

SHIELD HDPE Drainage pipes are manufactured in accordance with the European standard BS EN 1519-1 which supersedes the German standards DIN 19535-1 and DIN 19535-2.

Dimensions of HDPE drainage pipes according to **BS EN 1519-1:**

SD-PEPD

Nominal Outside Diameter	Outside Diameter		Wall Thickness S 16		Wall Thickness S 12.5	
	Minimum	Maximum	Minimum	Maximum	Minimum	Maximum
mm	mm	mm	mm	mm	mm	mm
32	32.0	32.0	3.0	3.5	3.0	3.5
40	40.0	40.4	3.0	3.5	3.0	3.5
50	50.0	50.5	3.0	3.5	3.0	3.5
56	56.0	56.5	3.0	3.5	3.0	3.5
63	63.0	63.6	3.0	3.5	3.0	3.5
75	75.0	75.7	3.0	3.5	3.0	3.5
80	80.0	80.9	3.0	3.5	3.1	3.6
90	90.0	90.9	3.0	3.5	3.5	4.1
100	100.0	100.9	3.2	3.8	3.9	4.4
110	110.0	111.0	3.4	4.0	4.2	4.9
125	125.0	126.2	3.9	4.5	4.9	5.5
160	160.0	161.5	4.9	5.6	6.2	7.1
200	200.0	201.8	6.2	7.1	7.7	9.7
250	250.0	252.3	7.7	9.7	9.6	10.8
315	315.0	317.9	9.7	10.9	12.1	13.6

**NOTE:**

- ▶ Series 16 (S 16) is suitable for application area inside buildings and outside buildings fixed on the wall.
- ▶ Series 12.5 (S 12.5) is suitable for application area under and within 1 metre from the building where the pipes and fittings are buried underground and connected to the soil and waste discharge system of the building.





SHIELD HDPE PIPE ISO 4437 PE 100

SHIELD MDPE PIPE ISO 4437

SHIELD HDPE

# HDPE Fittings

WRAS  
Water Regulations Advisory Scheme

Factory  
Mutual  
System

## Introduction:

SHIELD supplies a wide range of fittings used in PE piping industry, this range includes fittings for butt welded, Electro-Fusion welded and flanged connections.

These butt-welded fittings are of two types, moulded (injected) fittings and segmented fittings. The difference lies in the method of manufacturing. Moulded fittings are manufactured by injection moulding and segmented fittings are manufactured using HDPE pipes of the same class and standard using automatic welding machines that give no room for error to produce a homogeneous product. The high tech methods used for welding ensures the strongest joints. SHIELD fittings are FM and WRAS approved for different areas of usage.

Moulded and segmented fittings are manufactured according to ISO 4427, ANSI/AWWA C906 and BS EN 1519-1 standards.

### NOTE:

- ▶ For the details of the FM & WRAS approved HDPE fittings, please refer to respective certificates.
- ▶ Please contact us for more information.





# HDPE

fittings complying  
ISO 4427 standards



SHIELD fittings are available in moulded & segmented. They are manufactured as per ISO standard which are FM and WRAS approved, applicable for firefighting & water applications.

NOTE: Please contact us for more information.

# Moulded Fittings

(Metric)



## 90° Elbow (ISO 4427):

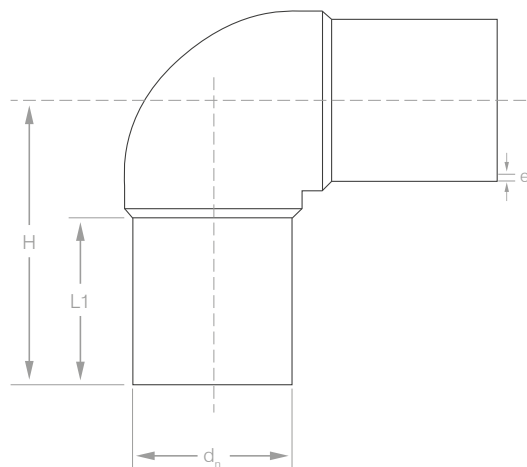

90° Elbow



### SD-PEM90E (PE 100 Long spigot version)

d <sub>n</sub>	D (Min - Max)	H	L1	e			
				SDR 17 PN10	SDR 11 PN16	SDR 9 PN20	SDR 7.4 PN25
mm	mm	mm	mm	mm	mm	mm	mm
20	20.0 - 20.1	75	49	-	2.0 - 2.3	2.3 - 2.7	3.0 - 3.4
25	25.0 - 25.1	80	53	-	2.3 - 2.7	3.0 - 3.4	3.5 - 4.0
32	32.0 - 32.1	89	59	-	3.0 - 3.4	3.6 - 4.1	4.4 - 5.0
40	40.0 - 40.2	89	59	-	3.7 - 4.2	4.5 - 5.1	5.5 - 6.2
50	50.0 - 50.3	89	60	-	4.6 - 5.2	5.6 - 6.3	6.9 - 7.7
63	63.0 - 63.4	115	65	-	5.8 - 6.5	7.1 - 8.0	8.6 - 9.6
75	75.0 - 75.5	130	75	-	6.8 - 7.6	8.4 - 9.4	10.3 - 11.5
90	90.0 - 90.6	145	80	5.4 - 6.1	8.2 - 9.2	10.1 - 11.1	12.3 - 13.7
110	110.0 - 110.7	165	88	6.6 - 7.4	10.0 - 11.1	12.3 - 13.7	15.1 - 16.8
125	125.0 - 125.8	180	95	7.4 - 8.3	11.4 - 12.7	14.0 - 15.6	17.1 - 19.0
160	160.0 - 161.0	215	110	9.5 - 10.6	14.6 - 16.2	17.9 - 19.8	21.9 - 24.2
180	180.0 - 181.1	230	115	10.7 - 11.9	16.4 - 18.2	20.1 - 22.3	24.6 - 27.2
200	200.0 - 201.2	250	125	11.9 - 13.2	18.2 - 20.2	22.4 - 24.8	27.4 - 30.3
225	225.0 - 226.4	285	135	13.4 - 14.9	20.5 - 22.7	25.2 - 27.9	30.8 - 34.0
250	250.0 - 251.5	310	140	14.8 - 16.4	22.7 - 25.1	27.9 - 30.8	34.2 - 37.8
280	280.0 - 281.7	265	120	16.6 - 18.4	25.4 - 28.1	31.3 - 34.6	38.3 - 42.3
315	315.0 - 316.9	290	110	18.7 - 20.7	28.6 - 31.6	35.2 - 38.9	43.1 - 47.6
355	355.0 - 357.2	365	155	21.1 - 23.4	32.2 - 35.6	39.7 - 43.8	48.5 - 53.5
400	400.0 - 402.4	375	155	23.7 - 26.2	36.3 - 40.1	44.7 - 49.3	54.7 - 60.3
450	450.0 - 452.7	425	175	26.7 - 29.5	40.9 - 45.1	50.3 - 55.5	61.5 - 67.8
500	500.0 - 503.0	445	170	29.7 - 32.8	45.4 - 50.1	55.8 - 61.5	68.2 - 75.4

NOTE:

- ▶ The tolerance limit for the dimensions (H & L1) will be ±5 mm.
- ▶ e = Thickness at the end.
- ▶ SDR 11 - 16 bar water/10 bar gas.
- ▶ Refer to FM & WRAS certificates for more details.
- ▶ Other SDRs are also available upon request.

# Moulded Fittings

(Metric)

## 45° Elbow (ISO 4427):

SD-PEM45E (PE 100 Long spigot version)

d <sub>n</sub>	D (Min - Max)	H	L1	e					
				SDR 17	SDR 11	SDR 9	SDR 7.4		
				PN10	PN16	PN20	PN25		
mm	mm	mm	mm	mm	mm	mm	mm	mm	mm
32	32.0 - 32.1	50	64	-	3.0 - 3.4	3.6 - 4.1	4.4 - 5.0		
40	40.0 - 40.2	59	71	-	3.7 - 4.2	4.5 - 5.1	5.5 - 6.2		
50	50.0 - 50.3	60	74	-	4.6 - 5.2	5.6 - 6.3	6.9 - 7.7		
63	63.0 - 63.4	90	65	-	5.8 - 6.5	7.1 - 8.0	8.6 - 9.6		
75	75.0 - 75.5	103	75	-	6.8 - 7.6	8.4 - 9.4	10.3 - 11.5		
90	90.0 - 90.6	112	80	5.4 - 6.1	8.2 - 9.2	10.1 - 11.1	12.3 - 13.7		
110	110.0 - 110.7	125	88	6.6 - 7.4	10.0 - 11.1	12.3 - 13.7	15.1 - 16.8		
125	125.0 - 125.8	140	95	7.4 - 8.3	11.4 - 12.7	14.0 - 15.6	17.1 - 19.0		
160	160.0 - 161.0	160	110	9.5 - 10.6	14.6 - 16.2	17.9 - 19.8	21.9 - 24.2		
180	180.0 - 181.1	180	115	10.7 - 11.9	16.4 - 18.2	20.1 - 22.3	24.6 - 27.2		
200	200.0 - 201.2	200	125	11.9 - 13.2	18.2 - 20.2	22.4 - 24.8	27.4 - 30.3		
225	225.0 - 226.4	215	135	13.4 - 14.9	20.5 - 22.7	25.2 - 27.9	30.8 - 34.0		
250	250.0 - 251.5	230	140	14.8 - 16.4	22.7 - 25.1	27.9 - 30.8	34.2 - 37.8		
280	280.0 - 281.7	185	119	16.6 - 18.4	25.4 - 28.1	31.3 - 34.6	38.3 - 42.3		
315	315.0 - 316.9	195	110	18.7 - 20.7	28.6 - 31.6	35.2 - 38.9	43.1 - 47.6		
355	355.0 - 357.2	265	165	21.1 - 23.4	32.2 - 35.6	39.7 - 43.8	48.5 - 53.5		
400	400.0 - 402.4	260	150	23.7 - 26.2	36.3 - 40.1	44.7 - 49.3	54.7 - 60.3		
450	450.0 - 452.7	280	160	26.7 - 29.5	40.9 - 45.1	50.3 - 55.5	61.5 - 67.8		
500	500.0 - 503.0	320	180	29.7 - 32.8	45.4 - 50.1	55.8 - 61.5	68.2 - 75.4		

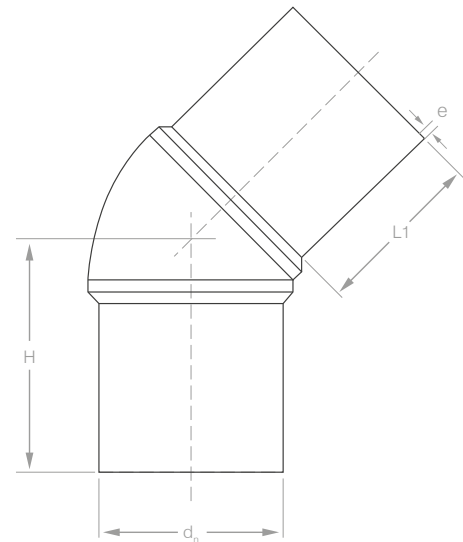

45° Elbow

**NOTE:**

- ▶ The tolerance limit for the dimensions (H & L1) will be ±5 mm.
- ▶ e = Thickness at the end.
- ▶ SDR 11 - 16 bar water/10 bar gas.
- ▶ Refer to FM & WRAS certificates for more details.
- ▶ Other SDRs are also available upon request.



# Moulded Fittings

(Metric)



## Equal Tee (ISO 4427):

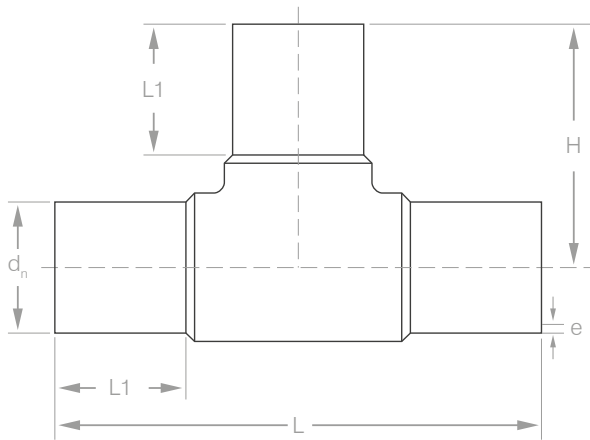

Equal Tee



## SD-PEMET (PE 100 Long spigot version)

d <sub>n</sub>	D (Min - Max)	H	L	L1	e			
					SDR 17	SDR 11	SDR 9	SDR 7.4
					PN10	PN16	PN20	PN25
mm	mm	mm	mm	mm	mm	mm	mm	mm
20	20.0 - 20.1	80	160	59	-	2.0 - 2.3	2.3 - 2.7	3.0 - 3.4
25	25.0 - 25.1	81	162	60	-	2.3 - 2.7	3.0 - 3.4	3.5 - 4.0
32	32.0 - 32.1	82	164	60	-	3.0 - 3.4	3.6 - 4.1	4.4 - 5.0
40	40.0 - 40.2	84	168	60	-	3.7 - 4.2	4.5 - 5.1	5.5 - 6.2
50	50.0 - 50.3	89	178	60	-	4.6 - 5.2	5.6 - 6.3	6.9 - 7.7
63	63.0 - 63.4	115	230	65	-	5.8 - 6.5	7.1 - 8.0	8.6 - 9.6
75	75.0 - 75.5	130	260	75	-	6.8 - 7.6	8.4 - 9.4	10.3 - 11.5
90	90.0 - 90.6	145	290	80	5.4 - 6.1	8.2 - 9.2	10.1 - 11.1	12.3 - 13.7
110	110.0 - 110.7	165	330	88	6.6 - 7.4	10.0 - 11.1	12.3 - 13.7	15.1 - 16.8
125	125.0 - 125.8	180	360	95	7.4 - 8.3	11.4 - 12.7	14.0 - 15.6	17.1 - 19.0
160	160.0 - 161.0	215	430	110	9.5 - 10.6	14.6 - 16.2	17.9 - 19.8	21.9 - 24.2
180	180.0 - 181.1	245	490	115	10.7 - 11.9	16.4 - 18.2	20.1 - 22.3	24.6 - 27.2
200	200.0 - 201.2	260	520	120	11.9 - 13.2	18.2 - 20.2	22.4 - 24.8	27.4 - 30.3
225	225.0 - 226.4	285	570	125	13.4 - 14.9	20.5 - 22.7	25.2 - 27.9	30.8 - 34.0
250	250.0 - 251.5	310	620	130	14.8 - 16.4	22.7 - 25.1	27.9 - 30.8	34.2 - 37.8
280	280.0 - 281.7	283	570	125	16.6 - 18.4	25.4 - 28.1	31.3 - 34.6	38.3 - 42.3
315	315.0 - 316.9	285	570	110	18.7 - 20.7	28.6 - 31.6	35.2 - 38.9	43.1 - 47.6
355	355.0 - 357.2	360	725	160	21.1 - 23.4	32.2 - 35.6	39.7 - 43.8	48.5 - 53.5
400	400.0 - 402.4	380	730	155	23.7 - 26.2	36.3 - 40.1	44.7 - 49.3	54.7 - 60.3
450	450.0 - 452.7	450	810	140	26.7 - 29.5	40.9 - 45.1	50.3 - 55.5	61.5 - 67.8
500	500.0 - 503.0	480	860	155	29.7 - 32.8	45.4 - 50.1	55.8 - 61.5	68.2 - 75.4

NOTE:

- ▶ The tolerance limit for the dimensions (L, H & L1) will be ±5 mm.
- ▶ e = Thickness at the end.
- ▶ SDR 11 - 16 bar water/10 bar gas.
- ▶ Refer to FM & WRAS certificates for more details.
- ▶ Other SDRs are also available upon request.

# Moulded Fittings



## Concentric Reducer (ISO 4427):

(Metric)

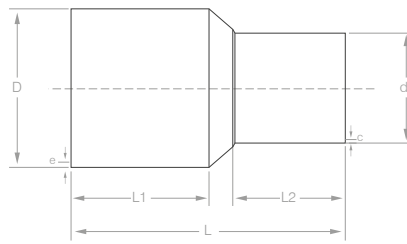

SD-PEMCR (PE 100 Long spigot version)

Concentric Reducer

D x d <sub>n</sub> mm	D (Min - Max) mm	d <sub>n</sub> (Min - Max) mm	L mm	L1 mm	L2 mm	e				c			
						SDR 17 PN10 mm	SDR 11 PN16 mm	SDR 9 PN20 mm	SDR 7.4 PN25 mm	SDR 17 PN10 mm	SDR 11 PN16 mm	SDR 9 PN20 mm	SDR 7.4 PN25 mm
						-	-	-	-	-	-	-	-
25 x 20	25.0 - 25.3	20.0 - 20.2	113	49	48	-	2.3 - 2.7	3.0 - 3.4	3.5 - 4.0	-	2.0 - 2.3	2.3 - 2.7	3.0 - 3.4
32 x 20	32.0 - 32.3	20.0 - 20.2	124	55	52	-	3.0 - 3.4	3.6 - 4.1	4.4 - 5.0	-	2.0 - 2.3	2.3 - 2.7	3.0 - 3.4
32 x 25	32.0 - 32.3	25.0 - 25.2	130	61	59	-	3.0 - 3.4	3.6 - 4.1	4.4 - 5.0	-	2.3 - 2.7	3.0 - 3.4	3.5 - 4.0
40 x 20	40.0 - 40.3	20.0 - 20.2	130	59	52	-	3.7 - 4.2	4.5 - 5.1	5.5 - 6.2	-	2.0 - 2.3	2.3 - 2.7	3.0 - 3.4
40 x 25	40.0 - 40.3	25.0 - 25.2	128	59	54	-	3.7 - 4.2	4.5 - 5.1	5.5 - 6.2	-	2.3 - 2.7	3.0 - 3.4	3.5 - 4.0
40 x 32	40.0 - 40.3	32.0 - 32.3	125	61	54	-	3.7 - 4.2	4.5 - 5.1	5.5 - 6.2	-	3.0 - 3.4	3.6 - 4.1	4.4 - 5.0
50 x 25	50.0 - 50.4	25.0 - 25.2	135	60	50	-	4.6 - 5.2	5.6 - 6.3	6.9 - 7.7	-	2.3 - 2.7	3.0 - 3.4	3.5 - 4.0
50 x 32	50.0 - 50.4	32.0 - 32.3	134	60	47	-	4.6 - 5.2	5.6 - 6.3	6.9 - 7.7	-	3.0 - 3.4	3.6 - 4.1	4.4 - 5.0
50 x 40	50.0 - 50.4	40.0 - 40.3	134	60	62	-	4.6 - 5.2	5.6 - 6.3	6.9 - 7.7	-	3.7 - 4.2	4.5 - 5.1	5.5 - 6.2
63 x 25	63.0 - 63.4	25.0 - 25.2	140	64	57	-	5.8 - 6.5	7.1 - 8.0	8.6 - 9.6	-	2.3 - 2.7	3.0 - 3.4	3.5 - 4.0
63 x 32	63.0 - 63.4	32.0 - 32.3	143	64	63	-	5.8 - 6.5	7.1 - 8.0	8.6 - 9.6	-	3.0 - 3.4	3.6 - 4.1	4.4 - 5.0
63 x 40	63.0 - 63.4	40.0 - 40.3	139	68	52	-	5.8 - 6.5	7.1 - 8.0	8.6 - 9.6	-	3.7 - 4.2	4.5 - 5.1	5.5 - 6.2
63 x 50	63.0 - 63.4	50.0 - 50.4	132	63	57	-	5.8 - 6.5	7.1 - 8.0	8.6 - 9.6	-	4.6 - 5.2	5.6 - 6.3	6.9 - 7.7
75 x 40	75.0 - 70.5	40.0 - 40.3	147	72	60	-	6.8 - 7.6	8.4 - 9.4	10.3 - 11.5	-	3.7 - 4.2	4.5 - 5.1	5.5 - 6.2
75 x 50	75.0 - 70.5	50.0 - 50.4	153	72	59	-	6.8 - 7.6	8.4 - 9.4	10.3 - 11.5	-	4.6 - 5.2	5.6 - 6.3	6.9 - 7.7
75 x 63	75.0 - 75.5	63.0 - 63.4	160	75	65	-	6.8 - 7.6	8.4 - 9.4	10.3 - 11.5	-	5.8 - 6.5	7.1 - 8.0	8.6 - 9.6
90 x 63	90.0 - 90.6	63.0 - 63.4	170	80	65	-	8.2 - 9.2	10.1 - 11.3	12.3 - 13.7	-	5.8 - 6.5	7.1 - 8.0	8.6 - 9.6
90 x 75	90.0 - 90.6	75.0 - 75.5	170	80	75	-	8.2 - 9.2	10.1 - 11.3	12.3 - 13.7	-	6.8 - 7.6	8.4 - 9.4	10.3 - 11.5
110 x 63	110.0 - 110.7	63.0 - 63.4	185	88	65	-	10.0 - 11.1	12.3 - 13.7	15.1 - 16.8	-	5.8 - 6.5	7.1 - 8.0	8.6 - 9.6
110 x 75	110.0 - 110.7	75.0 - 75.5	185	88	75	6.6 - 7.4	10.0 - 11.1	12.3 - 13.7	15.1 - 16.8	4.5 - 5.1	6.8 - 7.6	8.4 - 9.4	10.3 - 11.5
110 x 90	110.0 - 110.7	90.0 - 90.6	185	88	80	6.6 - 7.4	10.0 - 11.1	12.3 - 13.7	15.1 - 16.8	5.4 - 6.1	8.2 - 9.2	10.1 - 11.1	12.3 - 13.7
125 x 75	125.0 - 125.8	75.0 - 75.5	200	95	75	7.4 - 8.3	11.4 - 12.7	14.0 - 15.6	17.1 - 19.0	4.5 - 5.1	6.8 - 7.6	8.4 - 9.4	10.3 - 11.5
125 x 90	125.0 - 125.8	90.0 - 90.6	200	95	80	7.4 - 8.3	11.4 - 12.7	14.0 - 15.6	17.1 - 19.0	5.4 - 6.1	8.2 - 9.2	10.1 - 11.1	12.3 - 13.7
125 x 110	125.0 - 125.8	110.0 - 110.7	200	95	85	7.4 - 8.3	11.4 - 12.7	14.0 - 15.6	17.1 - 19.0	6.6 - 7.4	10.0 - 11.1	12.3 - 13.7	15.1 - 16.8
160 x 110	160.0 - 161.0	110.0 - 110.7	230	110	90	9.5 - 10.6	14.6 - 16.2	17.9 - 19.8	21.9 - 24.2	6.6 - 7.4	10.0 - 11.1	12.3 - 13.7	15.1 - 16.8
160 x 125	160.0 - 161.0	125.0 - 125.8	230	110	95	9.5 - 10.6	14.6 - 16.2	17.9 - 19.8	21.9 - 24.2	7.4 - 8.3	11.4 - 12.7	14.0 - 15.6	17.1 - 19.0
180 x 110	180.0 - 181.1	110.0 - 110.7	250	110	90	10.7 - 11.9	16.4 - 18.2	20.1 - 22.3	24.6 - 27.2	6.6 - 7.4	10.0 - 11.1	12.3 - 13.7	15.1 - 16.8
180 x 125	180.0 - 181.1	125.0 - 125.8	250	115	95	10.7 - 11.9	16.4 - 18.2	20.1 - 22.3	24.6 - 27.2	7.4 - 8.3	11.4 - 12.7	14.0 - 15.6	17.1 - 19.0
180 x 160	180.0 - 181.1	160.0 - 161.0	250	115	110	10.7 - 11.9	16.4 - 18.2	20.1 - 22.3	24.6 - 27.2	9.5 - 10.6	14.6 - 16.2	17.9 - 19.8	21.9 - 24.2
200 x 125	200.0 - 201.2	125.0 - 125.8	270	120	95	11.9 - 13.2	18.2 - 20.2	22.4 - 24.8	27.4 - 30.3	7.4 - 8.3	11.4 - 12.7	14.0 - 15.6	17.1 - 19.0
200 x 160	200.0 - 201.2	160.0 - 161.0	270	120	110	11.9 - 13.2	18.2 - 20.2	22.4 - 24.8	27.4 - 30.3	9.5 - 10.6	14.6 - 16.2	17.9 - 19.8	21.9 - 24.2
200 x 180	200.0 - 201.2	180.0 - 181.1	270	120	115	11.9 - 13.2	18.2 - 20.2	22.4 - 24.8	27.4 - 30.3	10.7 - 11.9	16.4 - 18.2	20.1 - 22.3	24.6 - 27.2
225 x 160	225.0 - 226.4	160.0 - 161.0	280	125	110	13.4 - 14.9	20.5 - 22.7	25.2 - 27.9	30.8 - 34.0	9.5 - 10.6	14.6 - 16.2	17.9 - 19.8	21.9 - 24.2
225 x 180	225.0 - 226.4	180.0 - 181.1	280	125	115	13.4 - 14.9	20.5 - 22.7	25.2 - 27.9	30.8 - 34.0	10.7 - 11.9	16.4 - 18.2	20.1 - 22.3	24.6 - 27.2
225 x 200	225.0 - 226.4	200.0 - 201.2	280	125	120	13.4 - 14.9	20.5 - 22.7	25.2 - 27.9	30.8 - 34.0	11.9 - 13.2	18.2 - 20.2	22.4 - 24.8	27.4 - 30.4
250 x 160	250.0 - 251.5	160.0 - 161.0	300	130	110	14.8 - 16.4	22.7 - 25.1	27.9 - 30.8	34.2 - 37.8	9.5 - 10.6	14.6 - 16.2	17.9 - 19.8	21.9 - 24.2
250 x 180	250.0 - 251.5	180.0 - 181.1	300	130	115	14.8 - 16.4	22.7 - 25.1	27.9 - 30.8	34.2 - 37.8	10.7 - 11.9	16.4 - 18.2	20.1 - 22.3	24.6 - 27.2
250 x 200	250.0 - 251.5	200.0 - 201.2	300	130	120	14.8 - 16.4	22.7 - 25.1	27.9 - 30.8	34.2 - 37.8	11.9 - 13.2	18.2 - 20.2	22.4 - 24.8	27.4 - 30.4
250 x 225	250.0 - 251.5	225.0 - 226.4	300	130	125	14.8 - 16.4	22.7 - 25.1	27.9 - 30.8	34.2 - 37.8	13.4 - 14.9	20.5 - 22.7	25.2 - 27.9	30.8 - 34.0

NOTE:

- ▶ The tolerance limit for the dimensions (L, L1 & L2) will be  $\pm 5$  mm.
- ▶ e & c = Thickness at the end.
- ▶ SDR 11 - 16 bar water/10 bar gas.
- ▶ Refer to FM & WRAS certificates for more details.
- ▶ Other SDRs are also available upon request.

# Moulded Fittings

(Metric)



## Concentric Reducer (ISO 4427):

SD-PEMCR (PE 100 Long spigot version)

D x d <sub>n</sub>	D (Min - Max)	d <sub>n</sub> (Min - Max)	L	L1	L2	e				c							
						SDR 17	SDR 11	SDR 9	SDR 7.4	SDR 17	SDR 11	SDR 9	SDR 7.4				
						PN10	PN16	PN20	PN25	PN10	PN16	PN20	PN25				
mm	mm	mm	mm	mm	mm	mm	mm	mm	mm	mm	mm	mm	mm	mm	mm	mm	mm
280 x 200	280.0 - 281.7	200.0 - 201.2	320	150	150	16.6 - 18.4	25.4 - 28.1	31.3 - 34.6	38.3 - 42.3	11.9 - 13.2	18.2 - 20.2	22.4 - 24.8	27.4 - 30.3				
280 x 225	280.0 - 281.7	225.0 - 226.4	320	150	150	16.6 - 18.4	25.4 - 28.1	31.3 - 34.6	38.3 - 42.3	13.4 - 14.9	20.5 - 22.7	25.2 - 27.9	30.8 - 34.0				
280 x 250	280.0 - 281.7	250.0 - 251.5	320	150	150	16.6 - 18.4	25.4 - 28.1	31.3 - 34.6	38.3 - 42.3	14.8 - 16.4	22.7 - 25.1	27.9 - 30.8	34.2 - 37.8				
315 x 200	315.0 - 316.9	200.0 - 201.2	350	150	150	18.7 - 20.7	28.6 - 31.6	35.2 - 38.9	43.1 - 47.6	11.9 - 13.2	18.2 - 20.2	22.4 - 24.8	27.4 - 30.3				
315 x 225	315.0 - 316.9	225.0 - 226.4	350	150	150	18.7 - 20.7	28.6 - 31.6	35.2 - 38.9	43.1 - 47.6	13.4 - 14.9	20.5 - 22.7	25.2 - 27.9	30.8 - 34.0				
315 x 250	315.0 - 316.9	250.0 - 251.5	350	150	150	18.7 - 20.7	28.6 - 31.6	35.2 - 38.9	43.1 - 47.6	14.8 - 16.4	22.7 - 25.1	27.9 - 30.8	34.2 - 37.8				
315 x 280	315.0 - 316.9	280.0 - 281.7	350	150	150	18.7 - 20.7	28.6 - 31.6	35.2 - 38.9	43.1 - 47.6	16.6 - 18.4	25.4 - 28.1	31.3 - 34.6	38.3 - 42.3				
355 x 200	355.0 - 357.2	200.0 - 201.2	350	150	150	21.1 - 23.4	32.2 - 35.6	39.7 - 43.8	48.5 - 53.5	11.9 - 13.2	18.2 - 20.2	22.4 - 24.8	27.4 - 30.3				
355 x 225	355.0 - 357.2	200.0 - 201.2	350	150	150	21.1 - 23.4	32.2 - 35.6	39.7 - 43.8	48.5 - 53.5	13.4 - 14.9	20.5 - 22.7	25.2 - 27.9	30.8 - 34.0				
355 x 280	355.0 - 357.2	280.0 - 281.7	350	150	150	21.1 - 23.4	32.2 - 35.6	39.7 - 43.8	48.5 - 53.5	16.6 - 18.4	25.4 - 28.1	31.3 - 34.6	38.3 - 42.3				
355 x 315	355.0 - 357.2	315.0 - 316.9	350	150	150	21.1 - 23.4	32.2 - 35.6	39.7 - 43.8	48.5 - 53.5	18.7 - 20.7	28.6 - 31.6	35.2 - 38.9	43.1 - 47.6				
400 x 280	400.0 - 402.4	280.0 - 281.7	400	160	160	23.7 - 26.2	36.3 - 40.1	44.7 - 49.3	54.7 - 60.3	16.6 - 18.4	25.4 - 28.1	31.3 - 34.6	38.3 - 42.3				
400 x 315	400.0 - 402.4	315.0 - 316.9	400	160	160	23.7 - 26.2	36.3 - 40.1	44.7 - 49.3	54.7 - 60.3	18.7 - 20.7	28.6 - 31.6	35.2 - 38.9	43.1 - 47.6				
400 x 355	400.0 - 402.4	355.0 - 357.2	400	160	160	23.7 - 26.2	36.3 - 40.1	44.7 - 49.3	54.7 - 60.3	21.1 - 23.4	32.2 - 35.6	39.7 - 43.8	48.5 - 53.5				
450 x 315	450.0 - 452.7	315.0 - 316.9	400	180	180	26.7 - 29.5	40.9 - 45.1	50.3 - 55.5	61.5 - 67.8	18.7 - 20.7	28.6 - 31.6	35.2 - 38.9	43.1 - 47.6				
450 x 355	450.0 - 452.7	355.0 - 357.2	400	180	180	26.7 - 29.5	40.9 - 45.1	50.3 - 55.5	61.5 - 67.8	21.1 - 23.4	32.2 - 35.6	39.7 - 43.8	48.5 - 53.5				
450 x 400	450.0 - 452.7	400.0 - 402.4	400	180	180	26.7 - 29.5	40.9 - 45.1	50.3 - 55.5	61.5 - 67.8	23.7 - 26.2	36.3 - 40.1	44.7 - 49.3	54.7 - 60.3				
500 x 355	500.0 - 503.0	355.0 - 357.2	450	200	200	29.7 - 32.8	45.4 - 50.1	55.8 - 61.5	68.2 - 75.4	21.1 - 23.4	32.2 - 35.6	39.7 - 43.8	48.5 - 53.5				
500 x 400	500.0 - 503.0	400.0 - 402.4	450	200	200	29.7 - 32.8	45.4 - 50.1	55.8 - 61.5	68.2 - 75.4	23.7 - 26.2	36.3 - 40.1	44.7 - 49.3	54.7 - 60.3				
500 x 450	500.0 - 503.0	450.0 - 452.7	450	200	200	29.7 - 32.8	45.4 - 50.1	55.8 - 61.5	68.2 - 75.4	26.7 - 29.5	40.9 - 45.1	50.3 - 55.5	61.5 - 67.8				

**NOTE:**

- ▶ The tolerance limit for the dimensions (L, L1 & L2) will be ±5 mm.
- ▶ e & c = Thickness at the end.
- ▶ SDR 11 - 16 bar water/10 bar gas.
- ▶ Refer to FM & WRAS certificates for more details.
- ▶ Other SDRs and sizes are also available upon request.

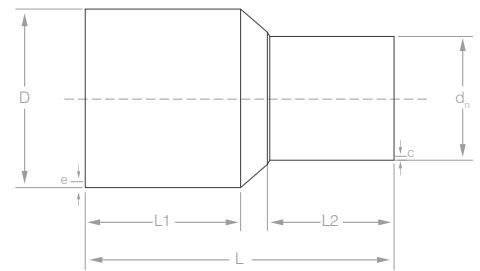

Concentric Reducer





# Moulded Fittings

(Metric)

## Stub Flange (ISO 4427):

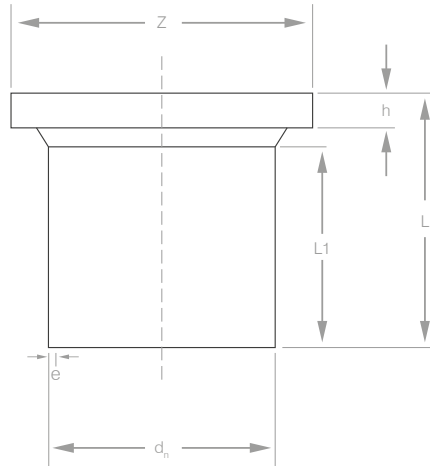

Stub Flange

## SD-PEMSF (PE 100 Long spigot version)

d <sub>n</sub> mm	D (Min - Max) mm	Z mm	L mm	L1 mm	h				e			
					SDR 17 PN10	SDR 11 PN16	SDR 9 PN20	SDR 7.4 PN25	SDR 17 PN10	SDR 11 PN16	SDR 9 PN20	SDR 7.4 PN25
					mm	mm	mm	mm	mm	mm	mm	mm
20	20.0 - 20.1	45	67	60	-	7	7	7	-	2.0 - 2.3	2.3 - 2.7	3.0 - 3.4
25	25.0 - 25.1	58	75	65	-	9	10	10	-	2.3 - 2.7	3.0 - 3.4	3.5 - 4.0
32	32.0 - 32.1	68	94	83	-	10	11	11	-	3.0 - 3.4	3.6 - 4.1	4.4 - 5.0
40	40.0 - 40.2	78	96	84	-	11	12	12	-	3.7 - 4.2	4.5 - 5.1	5.5 - 6.2
50	50.0 - 50.3	88	98	85	-	12	13	13	-	4.6 - 5.2	5.6 - 6.3	6.9 - 7.7
63	63.0 - 63.4	102	100	70	-	14	16	18	-	5.8 - 6.5	7.1 - 8.0	8.6 - 9.6
75	75.0 - 75.5	122	110	75	-	16	18	20	-	6.8 - 7.6	8.4 - 9.4	10.3 - 11.5
90	90.0 - 90.6	138	125	85	17	17	19	21	5.4 - 6.1	8.2 - 9.2	10.1 - 11.1	12.3 - 13.7
110	110.0 - 110.7	158	130	90	18	18	20	22	6.6 - 7.4	10.0 - 11.1	12.3 - 13.7	15.1 - 16.8
125	125.0 - 125.8	158	135	95	25	25	27	29	7.4 - 8.3	11.4 - 12.7	14.0 - 15.6	17.1 - 19.0
160	160.0 - 161.0	212	175	120	25	25	28	30	9.5 - 10.6	14.6 - 16.2	17.9 - 19.8	21.9 - 24.2
180	180.0 - 181.1	212	180	125	30	30	33	36	10.7 - 11.9	16.4 - 18.2	20.1 - 22.3	24.6 - 27.2
200	200.0 - 201.2	268	190	130	32	32	35	38	11.9 - 13.2	18.2 - 20.2	22.4 - 24.8	27.4 - 30.3
225	225.0 - 226.4	268	200	140	32	32	35	38	13.4 - 14.9	20.5 - 22.7	25.2 - 27.9	30.8 - 34.0
250	250.0 - 251.5	320	210	150	35	35	38	40	14.8 - 16.4	22.7 - 25.1	27.9 - 30.8	34.2 - 37.8
280	280.0 - 281.7	320	175	145	39	36	39	41	16.6 - 18.4	25.4 - 28.1	31.3 - 34.6	38.3 - 42.3
315	315.0 - 316.9	370	175	142	38	38	41	43	18.7 - 20.7	28.6 - 31.6	35.2 - 38.9	43.1 - 47.6
355	355.0 - 357.2	430	185	150	42	42	45	47	21.1 - 23.4	32.2 - 35.6	39.7 - 43.8	48.5 - 53.5
400	400.0 - 402.4	482	215	175	48	48	51	53	23.7 - 26.2	36.3 - 40.1	44.7 - 49.3	54.7 - 60.3
450	450.0 - 452.7	535	220	175	50	50	53	55	26.7 - 29.5	40.9 - 45.1	50.3 - 55.5	61.5 - 67.8
500	500.0 - 503.0	585	230	185	50	50	53	55	29.7 - 32.8	45.4 - 50.1	55.8 - 61.5	68.2 - 75.4

NOTE:

- ▶ The tolerance limit for the dimensions (Z, L, L1 & h) will be ±5 mm.
- ▶ e = Thickness at the end.
- ▶ SDR 11 - 16 bar water/10 bar gas.
- ▶ This product "Stub Flange" is usually used with G.I. backing ring and an EPDM rubber gasket, the whole assembly is called flange adapter set.
- ▶ Refer to FM & WRAS certificates for more details.
- ▶ Other SDRs and sizes are also available upon request.

# Moulded Fittings

(Metric)



## Short Stub Flange (ISO 4427):

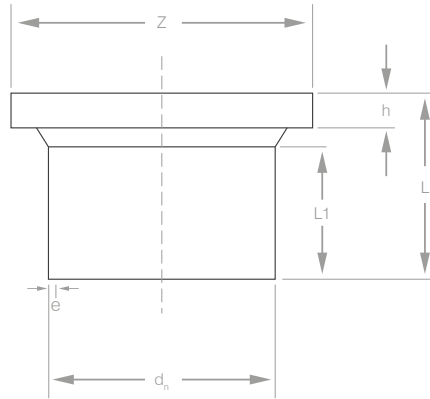

Short Stub Flange

## SD-PEMSSF (PE 100 Long spigot version)

d <sub>n</sub> mm	D (Min - Max) mm	Z mm	L mm	L1 mm	h				e			
					SDR 17 PN10	SDR 11 PN16	SDR 9 PN20	SDR 7.4 PN25	SDR 17 PN10	SDR 11 PN16	SDR 9 PN20	SDR 7.4 PN25
					mm	mm	mm	mm	mm	mm	mm	mm
200	200.0 - 201.2	270	128	58	32	32	35	38	11.9 - 13.2	18.2 - 20.2	22.4 - 24.8	27.4 - 30.3
225	225.0 - 226.4	270	122	58	32	32	35	38	13.4 - 14.9	20.5 - 22.7	25.2 - 27.9	30.8 - 34.0
250	250.0 - 251.5	320	115	40	35	35	38	40	14.8 - 16.4	22.7 - 25.1	27.9 - 30.8	34.2 - 37.8
280	280.0 - 281.7	320	110	40	39	36	39	41	16.6 - 18.4	25.4 - 28.1	31.3 - 34.6	38.3 - 42.3
315	315.0 - 316.9	370	125	40	38	38	41	43	18.7 - 20.7	28.6 - 31.6	35.2 - 38.9	43.1 - 47.6
355	355.0 - 357.2	430	125	40	42	42	45	47	21.1 - 23.4	32.2 - 35.6	39.7 - 43.8	48.5 - 53.5
400	400.0 - 402.4	480	146	45	48	48	51	53	23.7 - 26.2	36.3 - 40.1	44.7 - 49.3	54.7 - 60.3
450	450.0 - 452.7	535	155	35	50	50	53	55	26.7 - 29.5	40.9 - 45.1	50.3 - 55.5	61.5 - 67.8
500	500.0 - 503.0	585	175	50	50	50	53	55	29.7 - 32.8	45.4 - 50.1	55.8 - 61.5	68.2 - 75.4

NOTE:

- ▶ The tolerance limit for the dimensions (Z, L, L1 & h) will be ±5 mm.
- ▶ e = Thickness at the end.
- ▶ SDR 11 - 16 bar water/10 bar gas.
- ▶ This product "Stub Flange" is usually used with G.I. backing ring and an EPDM rubber gasket, the whole assembly is called flange adapter set.
- ▶ Refer to FM & WRAS certificates for more details.
- ▶ Other SDRs and sizes are also available upon request.

# Moulded Fittings

(Metric)

## End Cap (ISO 4427):

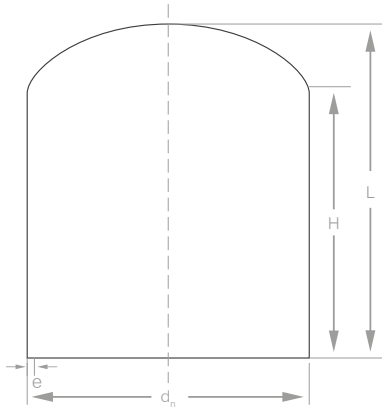

End Cap

## SD-PEMEC (PE 100 Long spigot version)

$d_n$	H	L	e			
			SDR 17 PN10	SDR 11 PN16	SDR 9 PN20	SDR 7.4 PN25
mm	mm	mm	mm	mm	mm	mm
20	54	59	-	2.0 - 2.3	2.3 - 2.7	3.0 - 3.4
25	60	68	-	2.3 - 2.7	3.0 - 3.4	3.5 - 4.0
32	53	59	-	3.0 - 3.4	3.6 - 4.1	4.4 - 5.0
40	57	68	-	3.7 - 4.2	4.5 - 5.1	5.5 - 6.2
50	61	74	-	4.6 - 5.2	5.6 - 6.3	6.9 - 7.7
63	64	80	-	5.8 - 6.5	7.1 - 8.0	8.6 - 9.6
75	74	89	-	6.8 - 7.6	8.4 - 9.4	10.3 - 11.5
90	82	100	5.4 - 6.1	8.2 - 9.2	10.1 - 11.1	12.3 - 13.7
110	91	118	6.6 - 7.4	10.0 - 11.1	12.3 - 13.7	15.1 - 16.8
125	102	122	7.4 - 8.3	11.4 - 12.7	14.0 - 15.6	17.1 - 19.0
160	101	134	9.5 - 10.6	14.6 - 16.2	17.9 - 19.8	21.9 - 24.2
180	114	150	10.7 - 11.9	16.4 - 18.2	20.1 - 22.3	24.6 - 27.2
200	119	163	11.9 - 13.2	18.2 - 20.2	22.4 - 24.8	27.4 - 30.3
225	124	180	13.4 - 14.9	20.5 - 22.7	25.2 - 27.9	30.8 - 34.0
250	132	179	14.8 - 16.4	22.7 - 25.1	27.9 - 30.8	34.2 - 37.8
280	137	183	16.6 - 18.4	25.4 - 28.1	31.3 - 34.6	38.3 - 42.3
315	175	298	18.7 - 20.7	28.6 - 31.6	35.2 - 38.9	43.1 - 47.6

**NOTE:**

- ▶ The tolerance limit for the dimensions (H & L) will be  $\pm 5$  mm.
- ▶ e = Thickness at the end.
- ▶ SDR 11 - 16 bar water/10 bar gas.
- ▶ Other SDRs and sizes are also available upon request.



# Segmented Fittings

(Metric)

## 90° Elbow (ISO 4427):

SD-PES90E (PE 100 - 3 Segments, Long spigot version)

d <sub>n</sub>	L <sub>e</sub>	Z	e			
			SDR 17 PN10	SDR 11 PN16	SDR 9 PN20	SDR 7.4 PN25
mm	mm	mm	mm	mm	mm	mm
90	150	225	5.4 - 6.1	8.2 - 9.2	10.1 - 11.1	12.3 - 13.7
110	150	315	6.6 - 7.4	10.0 - 11.1	12.3 - 13.7	15.1 - 16.8
125	150	338	7.4 - 8.3	11.4 - 12.7	14.0 - 15.6	17.1 - 19.0
160	150	390	9.5 - 10.6	14.6 - 16.2	17.9 - 19.8	21.9 - 24.2
180	150	420	10.7 - 11.9	16.4 - 18.2	20.1 - 22.3	24.6 - 27.2
200	150	450	11.9 - 13.2	18.2 - 20.2	22.4 - 24.8	27.4 - 30.3
225	150	488	13.4 - 14.9	20.5 - 22.7	25.2 - 27.9	30.8 - 34.0
250	250	625	14.8 - 16.4	22.7 - 25.1	27.9 - 30.8	34.2 - 37.8
280	250	670	16.6 - 18.4	25.4 - 28.1	31.3 - 34.6	38.3 - 42.3
315	300	773	18.7 - 20.7	28.6 - 31.6	35.2 - 38.9	43.1 - 47.6
355	300	833	21.1 - 23.4	32.2 - 35.6	39.7 - 43.8	48.5 - 53.5
400	300	900	23.7 - 26.2	36.3 - 40.1	44.7 - 49.3	54.7 - 60.3
450	300	975	26.7 - 29.5	40.9 - 45.1	50.3 - 55.5	61.5 - 67.8
500	350	1100	29.7 - 32.8	45.4 - 50.1	55.8 - 61.5	68.2 - 75.4
560	350	1190	34.3 - 37.8	50.8 - 56.0	62.5 - 68.9	-
630	350	1295	37.4 - 41.3	57.2 - 63.1	70.3 - 77.5	-
710	400	933	42.1 - 46.5	64.5 - 71.1	79.3 - 87.4	-
800	400	1000	47.4 - 52.3	72.6 - 80.0	89.3 - 98.4	-
900	400	1075	53.3 - 58.8	81.7 - 90.0	-	-



**NOTE:**

- ▶ e = Thickness at the end.
- ▶ Refer to FM & WRAS certificates for more details.
- ▶ Other SDRs are also available upon request.

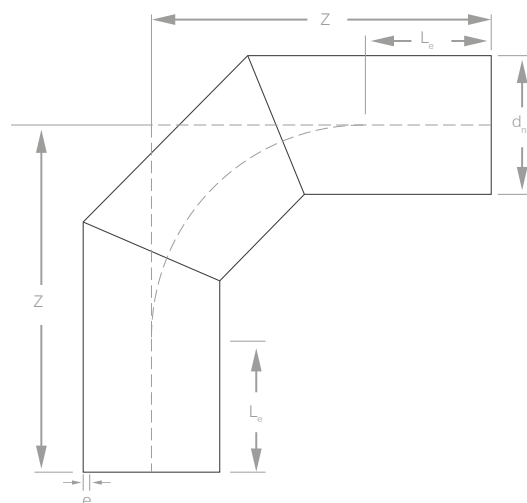

90° Elbow

# Segmented Fittings

(Metric)

**WRAS**  
Water Regulations Advisory Scheme



## 45° Elbow (ISO 4427):

SD-PES45E (PE 100 - 3 Segments, Long spigot version)

d <sub>n</sub>	L <sub>e</sub>	Z	e			
			SDR 17 PN10	SDR 11 PN16	SDR 9 PN20	SDR 7.4 PN25
mm	Min mm	Min mm	mm	mm	mm	mm
90	150	220	5.4 - 6.1	8.2 - 9.2	10.1 - 11.1	12.3 - 13.7
110	150	225	6.6 - 7.4	10.0 - 11.1	12.3 - 13.7	15.1 - 16.8
125	150	228	7.4 - 8.3	11.4 - 12.7	14.0 - 15.6	17.1 - 19.0
160	150	249	9.5 - 10.6	14.6 - 16.2	17.9 - 19.8	21.9 - 24.2
180	150	262	10.7 - 11.9	16.4 - 18.2	20.1 - 22.3	24.6 - 27.2
200	150	274	11.9 - 13.2	18.2 - 20.2	22.4 - 24.8	27.4 - 30.3
225	150	290	13.4 - 14.9	20.5 - 22.7	25.2 - 27.9	30.8 - 34.0
250	250	412	14.8 - 16.4	22.7 - 25.1	27.9 - 30.8	34.2 - 37.8
280	250	448	16.6 - 18.4	25.4 - 28.1	31.3 - 34.6	38.3 - 42.3
315	300	504	18.7 - 20.7	28.6 - 31.6	35.2 - 38.9	43.1 - 47.6
355	300	568	21.1 - 23.4	32.2 - 35.6	39.7 - 43.8	48.5 - 53.5
400	300	640	23.7 - 26.2	36.3 - 40.1	44.7 - 49.3	54.7 - 60.3
450	300	720	26.7 - 29.5	40.9 - 45.1	50.3 - 55.5	61.5 - 67.8
500	350	800	29.7 - 32.8	45.4 - 50.1	55.8 - 61.5	68.2 - 75.4
560	350	848	34.3 - 37.8	50.8 - 56.0	62.5 - 68.9	-
630	350	1008	37.4 - 41.3	57.2 - 63.1	70.3 - 77.5	-
710	400	675	42.1 - 46.5	64.5 - 71.1	79.3 - 87.4	-
800	400	720	47.4 - 52.3	72.6 - 80.0	89.3 - 98.4	-
900	400	775	53.3 - 58.8	81.7 - 90.0	-	-

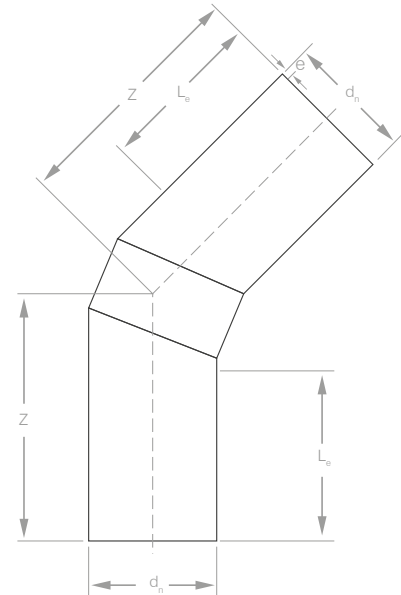

45° Elbow

**NOTE:**

- ▶ e = Thickness at the end.
- ▶ Refer to FM & WRAS certificates for more details.
- ▶ Other SDRs are also available upon request.

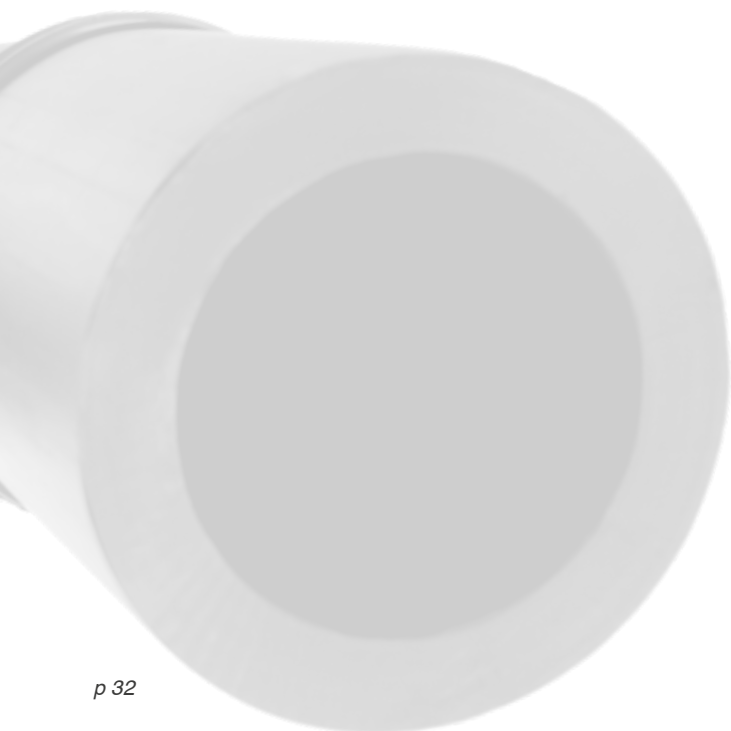

# Segmented Fittings

(Metric)

## 60°/30°/22.5°/11.25° Elbow (ISO 4427):

SD-PES60E, SD-PES30E, SD-PES225E & SD-PES1125E

(PE 100 - 3 Segments, Long spigot version)

d <sub>n</sub>	L <sub>o</sub>	Z				e			
		60° Min mm	30° Min mm	22.5° Min mm	11.25° Min mm	SDR 17 PN10 mm	SDR 11 PN16 mm	SDR 9 PN20 mm	SDR 7.4 PN25 mm
90	150	225	215	215	215	5.4 - 6.1	8.2 - 9.2	10.1 - 11.1	12.3 - 13.7
110	150	245	218	218	218	6.6 - 7.4	10.0 - 11.1	12.3 - 13.7	15.1 - 16.8
125	150	258	220	220	220	7.4 - 8.3	11.4 - 12.7	14.0 - 15.6	17.1 - 19.0
160	150	288	240	240	240	9.5 - 10.6	14.6 - 16.2	17.9 - 19.8	21.9 - 24.2
180	150	305	250	250	250	10.7 - 11.9	16.4 - 18.2	20.1 - 22.3	24.6 - 27.2
200	150	323	260	260	260	11.9 - 13.2	18.2 - 20.2	22.4 - 24.8	27.4 - 30.3
225	150	345	275	275	275	13.4 - 14.9	20.5 - 22.7	25.2 - 27.9	30.8 - 34.0
250	250	466	380	380	380	14.8 - 16.4	22.7 - 25.1	27.9 - 30.8	34.2 - 37.8
280	250	560	392	392	392	16.6 - 18.4	25.4 - 28.1	31.3 - 34.6	38.3 - 42.3
315	300	630	441	441	441	18.7 - 20.7	28.6 - 31.6	35.2 - 38.9	43.1 - 47.6
355	300	710	497	497	497	21.1 - 23.4	32.2 - 35.6	39.7 - 43.8	48.5 - 53.5
400	300	800	560	560	560	23.7 - 26.2	36.3 - 40.1	44.7 - 49.3	54.7 - 60.3
450	300	900	630	630	630	26.7 - 29.5	40.9 - 45.1	50.3 - 55.5	61.5 - 67.8
500	350	1000	700	700	700	29.7 - 32.8	45.4 - 50.1	55.8 - 61.5	68.2 - 75.4
560	350	1120	784	784	784	34.3 - 37.8	50.8 - 56.0	62.5 - 68.9	-
630	350	1260	882	882	882	37.4 - 41.3	57.2 - 63.1	70.3 - 77.5	-
710	400	750	608	608	608	42.1 - 46.5	64.5 - 71.1	79.3 - 87.4	-
800	400	800	648	648	648	47.4 - 52.3	72.6 - 80.0	89.3 - 98.4	-
900	400	860	698	698	698	53.3 - 58.8	81.7 - 90.0	-	-



**NOTE:**

- ▶ 11.25°/22.5°/30°/60° Elbows are also available upon request.
- ▶ e = Thickness at the end.
- ▶ Segmented fittings are also available in 2 segments upon request.
- ▶ Refer to FM & WRAS certificates for more details.
- ▶ Other SDRs are also available upon request.

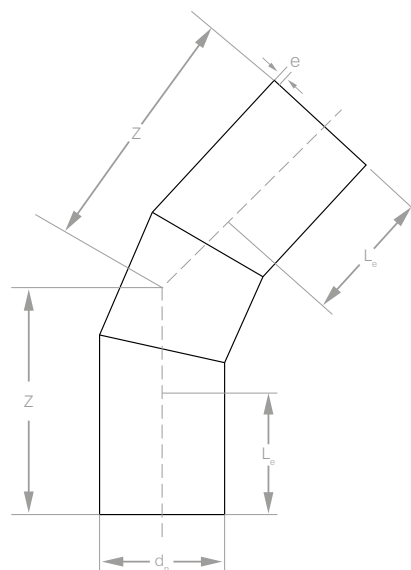

60°/30°/22.5°/11.25° Elbow

# Segmented Fittings

(Metric)



## Equal Tee (ISO 4427):

SD-PESET (PE 100 - 3 Segments, Long spigot version)

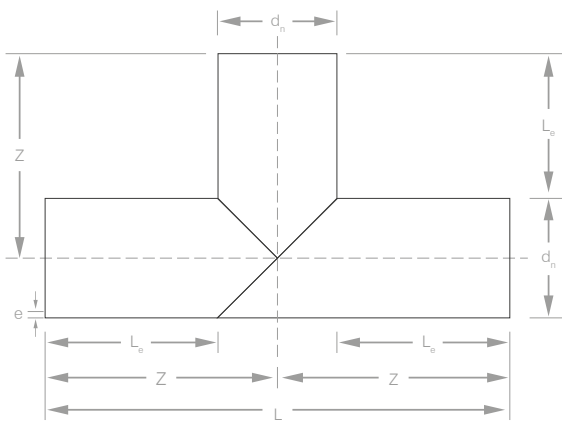

Equal Tee

d <sub>n</sub> mm	L <sub>o</sub> mm	Z mm	L mm	e			
				SDR 17 PN10 mm	SDR 11 PN16 mm	SDR 9 PN20 mm	SDR 7.4 PN25 mm
90	150	250	500	5.4 - 6.1	8.2 - 9.2	10.1 - 11.1	12.3 - 13.7
110	150	250	500	6.6 - 7.4	10.0 - 11.1	12.3 - 13.7	15.1 - 16.8
125	150	250	500	7.4 - 8.3	11.4 - 12.7	14.0 - 15.6	17.1 - 19.0
140	150	250	500	8.3 - 9.3	12.7 - 14.1	15.7 - 17.4	19.2 - 21.3
160	150	250	500	9.5 - 10.6	14.6 - 16.2	17.9 - 19.8	21.9 - 24.2
180	150	300	600	10.7 - 11.9	16.4 - 18.2	20.1 - 22.3	24.6 - 27.2
200	150	300	600	11.9 - 13.2	18.2 - 20.2	22.4 - 24.8	27.4 - 30.3
225	150	300	600	13.4 - 14.9	20.5 - 22.7	25.2 - 27.9	30.8 - 34.0
250	250	375	750	14.8 - 16.4	22.7 - 25.1	27.9 - 30.8	34.2 - 37.8
280	250	490	980	16.6 - 18.4	25.4 - 28.1	31.3 - 34.6	38.3 - 42.3
315	300	560	1120	18.7 - 20.7	28.6 - 31.6	35.2 - 38.9	43.1 - 47.6
355	300	580	1160	21.1 - 23.4	32.2 - 35.6	39.7 - 43.8	48.5 - 53.5
400	300	600	1200	23.7 - 26.2	36.3 - 40.1	44.7 - 49.3	54.7 - 60.3
450	300	625	1250	26.7 - 29.5	40.9 - 45.1	50.3 - 55.5	61.5 - 67.8
500	350	700	1400	29.7 - 32.8	45.4 - 50.1	55.8 - 61.5	68.2 - 75.4
560	350	730	1460	34.3 - 37.8	50.8 - 56.0	62.5 - 68.9	-
630	350	765	1530	37.4 - 41.3	57.2 - 63.1	70.3 - 77.5	-
710	400	800	1600	42.1 - 46.5	64.5 - 71.1	79.3 - 87.4	-
800	400	900	1800	47.4 - 52.3	72.6 - 80.0	89.3 - 98.4	-
900	400	1000	2000	53.3 - 58.8	81.7 - 90.0	-	-

NOTE:

- ▶ e = Thickness at the end.
- ▶ Refer to FM & WRAS certificates for more details.
- ▶ Other SDRs are also available upon request.







# Segmented Fittings

(Metric)

## Cross Tee (ISO 4427):

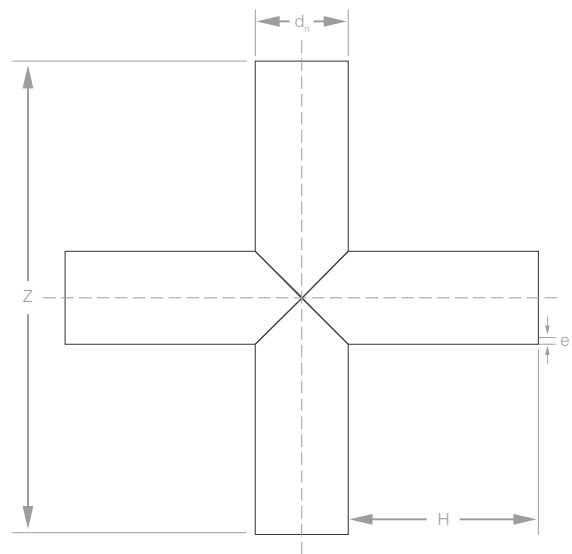
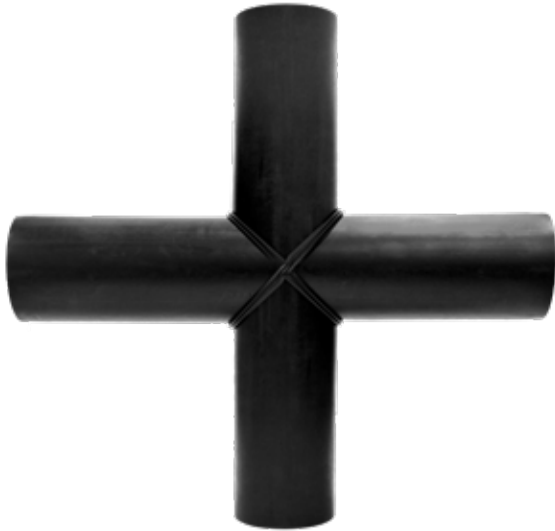

Cross Tee

SD-PESCT (PE 100 - 4 Segments, Long spigot version)

d <sub>n</sub>	H	Z	e			
			SDR 17 PN10	SDR 11 PN16	SDR 9 PN20	SDR 7.4 PN25
mm	mm	mm	mm	mm	mm	mm
110	100	310	6.6 - 7.4	10.0 - 11.1	12.3 - 13.7	15.1 - 16.8
125	150	325	7.4 - 8.3	11.4 - 12.7	14.0 - 15.6	17.1 - 19.0
160	150	460	9.5 - 10.6	14.6 - 16.2	17.9 - 19.8	21.9 - 24.2
180	200	580	10.7 - 11.9	16.4 - 18.2	20.1 - 22.3	24.6 - 27.2
200	200	600	11.9 - 13.2	18.2 - 20.2	22.4 - 24.8	27.4 - 30.3
225	200	625	13.4 - 14.9	20.5 - 22.7	25.2 - 27.9	30.8 - 34.0
250	200	650	14.8 - 16.4	22.7 - 25.1	27.9 - 30.8	34.2 - 37.8
280	200	680	16.6 - 18.4	25.4 - 28.1	31.3 - 34.6	38.3 - 42.3
315	300	915	18.7 - 20.7	28.6 - 31.6	35.2 - 38.9	43.1 - 47.6
355	300	955	21.1 - 23.4	32.2 - 35.6	39.7 - 43.8	48.5 - 53.5
400	300	1000	23.7 - 26.2	36.3 - 40.1	44.7 - 49.3	54.7 - 60.3
450	300	1050	26.7 - 29.5	40.9 - 45.1	50.3 - 55.5	61.5 - 67.8
500	300	1100	29.7 - 32.8	45.4 - 50.1	55.8 - 61.5	68.2 - 75.4
560	350	1260	34.3 - 37.8	50.8 - 56.0	62.5 - 68.9	-
630	350	1330	37.4 - 41.3	57.2 - 63.1	70.3 - 77.5	-

NOTE:

- ▶ e = Thickness at the end.
- ▶ Other SDRs are also available upon request.



# HDPE

fittings complying  
ANSI/AWWA standards



SHIELD moulded & segmented fittings are manufactured as per ANSI/AWWA C906 standards which meet the National Fire Protection Association (NFPA) requirements. Fittings are FM & WRAS approved, available in DR 11, DR 9, DR 7.3 & DR 7.

NOTE:

- ▶ Refer to FM & WRAS certificates for more information.
- ▶ Please contact us for more information.

# Moulded Fittings

(Imperial)



## 90° Elbow (ANSI/AWWA C906):

SD-PEM90E (PE 100/PE 4710 Long spigot version)

d <sub>n</sub>	D (Min - Max)	H	L1	e			
				DR 11	DR 9	DR 7.3	DR 7
				PC200	PC250	PC317	PC335
Inch	Inch	Inch	Inch	Inch	Inch	Inch	Inch
4	4.48 - 4.52	6.70	3.54	0.409 - 0.458	0.500 - 0.560	0.625 - 0.700	0.643 - 0.720
6	6.60 - 6.65	8.66	4.33	0.602 - 0.674	0.736 - 0.825	0.920 - 1.031	0.946 - 1.060
8	8.60 - 8.66	10.62	4.92	0.784 - 0.878	0.958 - 1.073	1.198 - 1.342	1.228 - 1.376
10	10.70 - 10.78	12.20	5.11	0.977 - 1.094	1.194 - 1.337	1.473 - 1.650	1.536 - 1.720

**NOTE:**

- ▶ The tolerance limit for the dimensions (H & L1) will be ±0.2 inch.
- ▶ e = Thickness at the end.
- ▶ Refer to FM & WRAS certificates for more information.

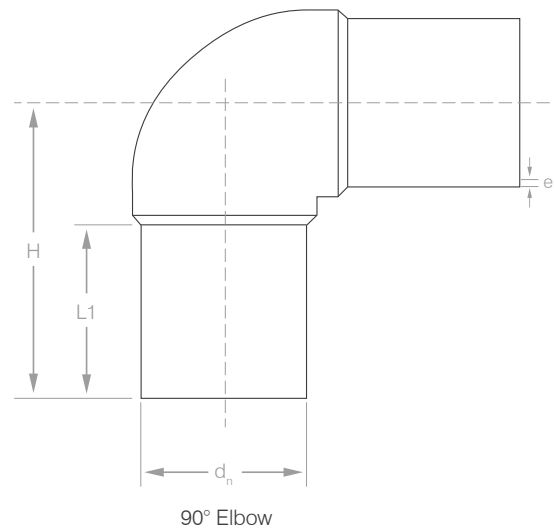

# Moulded Fittings

(Imperial)

## 45° Elbow (ANSI/AWWA C906):

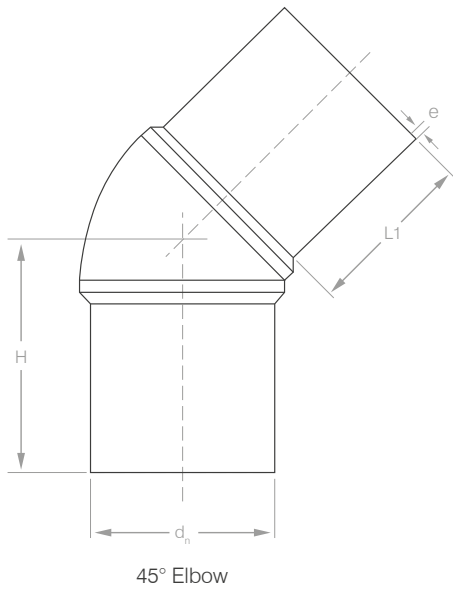

SD-PEM45E (PE 100/PE 4710 Long spigot version)

d <sub>n</sub>	Diameter (Min - Max)	H	L1	e			
				DR 11 PC200	DR 9 PC250	DR 7.3 PC317	DR 7 PC335
Inch	Inch	Min Inch	Min Inch	Inch	Inch	Inch	Inch
4	4.48 - 4.52	6.70	3.54	0.409 - 0.458	0.500 - 0.560	0.625 - 0.700	0.643 - 0.720
6	6.60 - 6.65	8.66	4.33	0.602 - 0.674	0.736 - 0.825	0.920 - 1.031	0.946 - 1.060
8	8.60 - 8.66	10.62	4.92	0.784 - 0.878	0.958 - 1.073	1.198 - 1.342	1.228 - 1.376
10	10.70 - 10.78	12.20	5.11	0.977 - 1.094	1.194 - 1.337	1.473 - 1.650	1.536 - 1.720

**NOTE:**

- ▶ The tolerance limit for the dimensions (H & L1) will be ±0.2 inch.
- ▶ e = Thickness at the end.
- ▶ Refer to FM & WRAS certificates for more information.

# Moulded Fittings

(Imperial)



## Equal Tee (ANSI/AWWA C906):

SD-PEMET (PE 100/PE 4710 Long spigot version)

d <sub>n</sub>	Diameter (Min - Max)	H	L	L1	e			
					DR 11	DR 9	DR 7.3	DR 7
					PC200	PC250	PC317	PC335
Inch	Inch	Inch	Inch	Inch	Inch	Inch	Inch	Inch
4	4.48 - 4.52	6.70	13.38	3.54	0.409 - 0.458	0.500 - 0.560	0.625 - 0.700	0.643 - 0.720
6	6.60 - 6.65	8.66	17.32	4.33	0.602 - 0.674	0.736 - 0.825	0.920 - 1.031	0.946 - 1.060
8	8.60 - 8.66	10.62	21.25	4.92	0.784 - 0.878	0.958 - 1.073	1.198 - 1.342	1.228 - 1.376
10	10.70 - 10.78	11.81	23.62	5.11	0.977 - 1.094	1.194 - 1.337	1.473 - 1.650	1.536 - 1.720

**NOTE:**

- ▶ The tolerance limit for the dimensions (L, H & L1) will be ±0.2 inch.
- ▶ e = Thickness at the end.
- ▶ Refer to FM & WRAS certificates for more information.

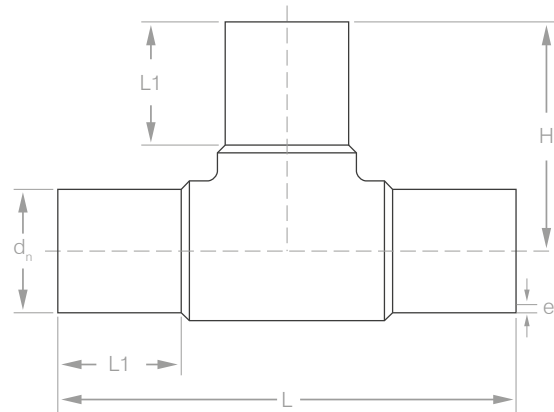

Equal Tee



# Moulded Fittings

(Imperial)



## Concentric Reducer (ANSI/AWWA C906):

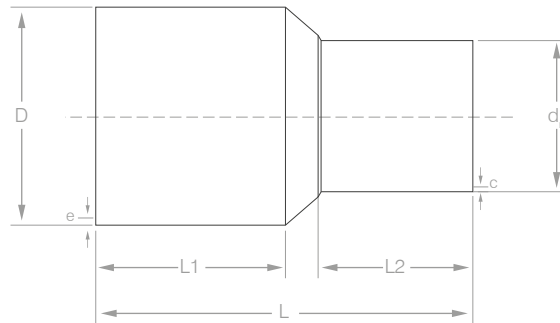

Concentric Reducer

SD-PEMCR (PE 100/PE 4710 Long spigot version)

D x d <sub>n</sub>	D (Min - Max)	d <sub>n</sub> (Min - Max)	L	L1	L2	e				c			
						DR 11	DR 9	DR 7.3	DR 7	DR 11	DR 9	DR 7.3	DR 7
						PC200	PC250	PC317	PC335	PC200	PC250	PC317	PC335
Inch	Inch	Inch	Min Inch	Min Inch	Min Inch	Inch	Inch	Inch	Inch	Inch	Inch	Inch	Inch
6 x 4	6.60 - 6.66	4.50 - 4.52	11.02	4.52	3.50	0.602 - 0.674	0.736 - 0.825	0.920 - 1.031	0.946 - 1.060	0.409 - 0.458	0.500 - 0.560	0.625 - 0.700	0.643 - 0.720
8 x 6	8.60 - 8.66	6.60 - 6.65	12.00	4.52	4.00	0.784 - 0.878	0.958 - 1.073	1.198 - 1.342	1.228 - 1.376	0.602 - 0.674	0.736 - 0.825	0.920 - 1.031	0.946 - 1.060
10 x 6	10.70 - 10.80	6.60 - 6.65	16.00	4.52	6.00	0.977 - 1.094	1.194 - 1.337	1.473 - 1.650	1.536 - 1.720	0.602 - 0.674	0.736 - 0.825	0.920 - 1.031	0.946 - 1.060
10 x 8	10.70 - 10.80	8.60 - 8.66	16.00	4.52	6.00	0.977 - 1.094	1.194 - 1.337	1.473 - 1.650	1.536 - 1.720	0.784 - 0.878	0.958 - 1.073	1.198 - 1.342	1.228 - 1.376
12 x 8	12.70 - 12.80	8.60 - 8.66	16.00	4.52	6.00	1.159 - 1.298	1.417 - 1.587	1.747 - 1.957	1.821 - 2.039	0.784 - 0.878	0.958 - 1.073	1.198 - 1.342	1.228 - 1.376
12 x 10	12.70 - 12.80	10.70 - 10.78	16.00	4.52	6.00	1.159 - 1.298	1.417 - 1.587	1.747 - 1.957	1.821 - 2.039	0.977 - 1.094	1.194 - 1.337	1.473 - 1.650	1.536 - 1.720
14 x 8	13.93 - 14.10	8.60 - 8.66	18.03	7.00	7.00	1.273 - 1.426	1.556 - 1.743	1.918 - 2.148	2.000 - 2.240	0.784 - 0.878	0.958 - 1.073	1.198 - 1.342	1.228 - 1.376
14 x 10	13.93 - 14.10	10.70 - 10.78	18.03	7.00	7.00	1.273 - 1.426	1.556 - 1.743	1.918 - 2.148	2.000 - 2.240	0.977 - 1.094	1.194 - 1.337	1.473 - 1.650	1.536 - 1.720
14 x 12	13.93 - 14.10	12.70 - 12.80	18.03	7.00	7.00	1.273 - 1.426	1.556 - 1.743	1.918 - 2.148	2.000 - 2.240	1.159 - 1.298	1.417 - 1.587	1.747 - 1.957	1.821 - 2.039
16 x 10	15.92 - 16.10	10.70 - 10.78	18.03	7.00	7.00	1.455 - 1.630	1.778 - 1.992	2.192 - 2.455	2.286 - 2.560	0.977 - 1.094	1.194 - 1.337	1.473 - 1.650	1.536 - 1.720
16 x 12	15.92 - 16.10	12.70 - 12.80	18.03	7.00	7.00	1.455 - 1.630	1.778 - 1.992	2.192 - 2.455	2.286 - 2.560	1.159 - 1.298	1.417 - 1.587	1.747 - 1.957	1.821 - 2.039
16 x 14	15.92 - 16.10	13.93 - 14.10	18.03	7.00	7.00	1.455 - 1.630	1.778 - 1.992	2.192 - 2.455	2.286 - 2.560	1.273 - 1.426	1.556 - 1.743	1.918 - 2.148	1.228 - 1.376
18 x 12	17.91 - 18.10	12.70 - 12.80	18.03	7.00	7.00	1.636 - 1.832	2.000 - 2.240	2.466 - 2.762	2.571 - 2.879	1.159 - 1.298	1.417 - 1.587	1.747 - 1.957	1.821 - 2.039
18 x 14	17.91 - 18.10	13.93 - 14.10	18.03	7.00	7.00	1.636 - 1.832	2.000 - 2.240	2.466 - 2.762	2.571 - 2.879	1.273 - 1.426	1.556 - 1.743	1.918 - 2.148	2.000 - 2.240
18 x 16	17.91 - 18.10	15.92 - 16.10	18.03	7.00	7.00	1.636 - 1.832	2.000 - 2.240	2.466 - 2.762	2.571 - 2.879	1.455 - 1.630	1.778 - 1.992	2.192 - 2.455	2.286 - 2.560
20 x 14	19.90 - 20.10	13.93 - 14.10	18.03	7.00	7.00	1.818 - 2.036	2.222 - 2.489	2.740 - 3.069	2.857 - 3.200	1.273 - 1.426	1.556 - 1.743	1.918 - 2.148	2.000 - 2.240
20 x 16	19.90 - 20.10	15.92 - 16.10	18.03	7.00	7.00	1.818 - 2.036	2.222 - 2.489	2.740 - 3.069	2.857 - 3.200	1.455 - 1.630	1.778 - 1.992	2.192 - 2.455	2.286 - 2.560
20 x 18	19.90 - 20.10	17.91 - 18.10	18.03	7.00	7.00	1.818 - 2.036	2.222 - 2.489	2.740 - 3.069	2.857 - 3.200	1.636 - 1.832	2.000 - 2.240	2.466 - 2.762	2.571 - 2.879

NOTE:

- ▶ The tolerance limit for the dimensions (L, L1, & L2) will be ±0.2 inch.
- ▶ e & c = Thickness at the end.
- ▶ Refer to FM & WRAS certificates for more information.

# Moulded Fittings

(Imperial)



## Stub Flange (ANSI/AWWA C906):

SD-PESSF (PE 100/PE 4710 - Long spigot version)

d <sub>n</sub>	D	L1	L	h	e				
					DR 11	DR 9	DR 7.3	DR 7	
					PC200	PC250	PC317	PC335	
Inch	Inch	Inch	Inch	Inch	Inch	Inch	Inch	Inch	Inch
4	6.22	3.50	5.12	0.79	0.41 - 0.46	0.50 - 0.55	0.63 - 0.70	0.64 - 0.72	
6	8.35	4.72	6.89	0.98	0.60 - 0.67	0.74 - 0.82	0.92 - 1.03	0.95 - 1.06	
8	10.55	4.92	7.99	1.38	0.80 - 0.90	0.96 - 1.07	1.20 - 1.34	1.23 - 1.38	
10	12.60	5.12	8.78	1.57	1.00 - 1.10	1.19 - 1.33	1.47 - 1.65	1.54 - 1.72	
12	13.39	5.12	9.06	1.57	1.15 - 1.30	1.42 - 1.59	1.75 - 1.96	1.82 - 2.04	
14	16.54	6.30	9.33	1.57	1.27 - 1.43	1.56 - 1.74	1.92 - 2.15	2.00 - 2.24	
16	18.90	5.51	10.08	1.57	1.45 - 1.63	1.78 - 1.99	2.19 - 2.46	2.29 - 2.56	
18	20.87	5.51	10.63	1.77	1.63 - 1.83	2.00 - 2.24	2.47 - 2.76	2.57 - 2.88	
20	23.03	5.91	10.71	1.77	1.81 - 2.04	2.22 - 2.49	2.74 - 3.07	2.86 - 3.20	

**NOTE:**

- ▶ e = Thickness at the end.
- ▶ This product "Stub Flange" is usually used with G.I. backing ring and an EPDM rubber gasket, the whole assembly is called flange adapter set.
- ▶ Refer to FM & WRAS certificates for more information.

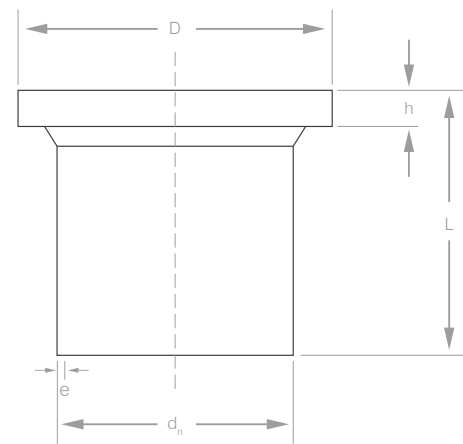

Stub Flange





# Segmented Fittings

(Imperial)



## 90° Elbow (ANSI/AWWA C906):

SD-PES90E (PE 100/PE 4710 - 3 Segments, Long spigot version)

d <sub>n</sub>	L <sub>o</sub>	Z	e			
			DR 11 PC200	DR 9 PC250	DR 7.3 PC317	DR 7 PC335
Inch	Min Inch	Min Inch	Inch	Inch	Inch	Inch
4	5.91	12.64	0.409 - 0.458	0.500 - 0.560	0.625 - 0.700	0.643 - 0.720
6	7.87	17.76	0.602 - 0.674	0.736 - 0.825	0.920 - 1.031	0.946 - 1.060
8	9.84	22.72	0.784 - 0.878	0.958 - 1.073	1.198 - 1.342	1.228 - 1.376
10	11.81	27.83	0.977 - 1.094	1.194 - 1.337	1.473 - 1.650	1.536 - 1.720
12	11.81	30.87	1.159 - 1.298	1.417 - 1.587	1.747 - 1.957	1.821 - 2.039
14	11.81	32.72	1.273 - 1.426	1.556 - 1.743	1.918 - 2.148	2.000 - 2.240
16	11.81	35.71	1.455 - 1.630	1.778 - 1.992	2.192 - 2.455	2.286 - 2.560
18	11.81	38.70	1.636 - 1.832	2.00 - 2.240	2.466 - 2.762	2.571 - 2.879
20	11.81	41.65	1.818 - 2.036	2.222 - 2.489	2.740 - 3.069	2.857 - 3.200
22	13.78	30.24	2.000 - 2.240	2.444 - 2.737	3.014 - 3.376	3.143 - 3.520
24	13.78	31.69	2.182 - 2.444	2.667 - 2.987	3.288 - 3.683	3.429 - 3.841
26	13.78	33.19	2.364 - 2.648	2.889 - 3.236	3.562 - 3.989	3.714 - 4.160
28	13.78	34.69	2.545 - 2.850	3.111 - 3.484	3.836 - 4.296	-
30	15.75	38.15	2.727 - 3.054	3.333 - 3.733	-	-
32	15.75	39.65	2.909 - 3.258	3.556 - 3.983	-	-
34	15.75	41.14	3.091 - 3.462	3.778 - 4.231	-	-
36	15.75	42.64	3.273 - 3.666	-	-	-
42	19.69	51.06	3.818 - 4.276	-	-	-

**NOTE:**

- ▶ The tolerance limit for the angle (α) will be ±2°.
- ▶ e = Thickness at the end.
- ▶ Refer to FM & WRAS certificates for more information.

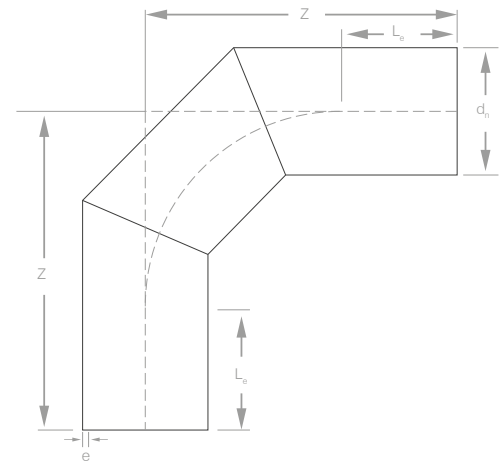

90° Elbow



# Segmented Fittings

(Imperial)

## 45° Elbow (ANSI/AWWA C906):

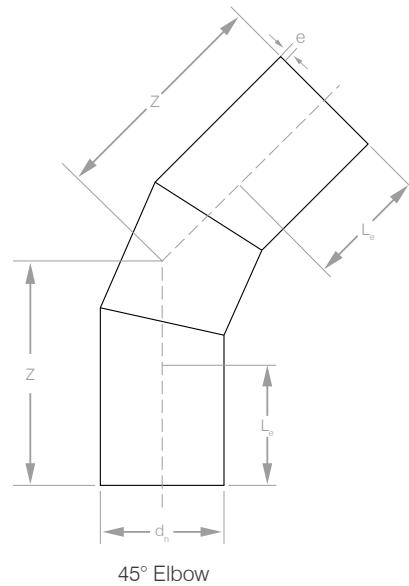

### SD-PES45E (PE 100/PE 4710 - 3 Segments, Long spigot version)

d <sub>n</sub>	L <sub>e</sub>	Z	e			
			DR 11 PC200	DR 9 PC250	DR 7.3 PC317	DR 7 PC335
Inch	Min Inch	Min Inch	Inch	Inch	Inch	Inch
4	5.91	9.45	0.409 - 0.458	0.500 - 0.560	0.625 - 0.700	0.643 - 0.720
6	7.87	11.02	0.602 - 0.674	0.736 - 0.825	0.920 - 1.031	0.946 - 1.060
8	9.84	12.80	0.784 - 0.878	0.958 - 1.073	1.198 - 1.342	1.228 - 1.376
10	11.81	13.78	0.977 - 1.094	1.194 - 1.337	1.473 - 1.650	1.536 - 1.720
12	11.81	17.64	1.159 - 1.298	1.417 - 1.587	1.747 - 1.957	1.821 - 2.039
14	11.81	19.84	1.273 - 1.426	1.556 - 1.743	1.918 - 2.148	2.000 - 2.240
16	11.81	22.36	1.455 - 1.630	1.778 - 1.992	2.192 - 2.455	2.286 - 2.560
18	11.81	25.20	1.636 - 1.832	2.00 - 2.240	2.466 - 2.762	2.571 - 2.879
20	11.81	28.35	1.818 - 2.036	2.222 - 2.489	2.740 - 3.069	2.857 - 3.200
22	13.78	24.53	2.000 - 2.240	2.444 - 2.737	3.014 - 3.376	3.143 - 3.520
24	13.78	25.71	2.182 - 2.444	2.667 - 2.987	3.288 - 3.683	3.429 - 3.841
26	13.78	26.89	2.364 - 2.648	2.889 - 3.236	3.562 - 3.989	3.714 - 4.160
28	13.78	28.11	2.545 - 2.850	3.111 - 3.484	3.836 - 4.296	-
30	15.75	30.91	2.727 - 3.054	3.333 - 3.733	-	-
32	15.75	32.09	2.909 - 3.258	3.556 - 3.983	-	-
34	15.75	33.35	3.091 - 3.462	3.778 - 4.231	-	-
36	15.75	34.57	3.273 - 3.666	-	-	-
42	19.69	41.34	3.818 - 4.276	-	-	-

**NOTE:**

- ▶ The tolerance limit for the angle (α) will be ±2°.
- ▶ e = Thickness at the end.
- ▶ Refer to FM & WRAS certificates for more information.



# Segmented Fittings

(Imperial)

**WRAS**  
Water Regulations Advisory Scheme



## 60°/30°/22.5°/11.25° Elbow (ANSI/AWWA C906):

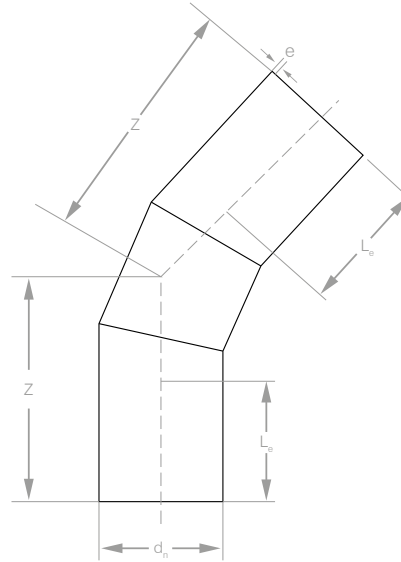

60°/30°/22.5°/11.25° Elbow

SD-PES60E, SD-PES30E, SD-PES225E & SD-PES1125E  
(PE 100/PE 4710 - 3 Segments, Long spigot version)

d <sub>n</sub>	L <sub>e</sub>	Z				e			
		60°	30°	22.5°	11.25°	DR 11 PC200	DR 9 PC250	DR 7.3 PC317	DR 7 PC335
Inch	Min Inch	Min Inch	Min Inch	Min Inch	Min Inch	Inch	Inch	Inch	Inch
4	5.91	11.02	8.66	8.66	8.66	0.409 - 0.458	0.500 - 0.560	0.625 - 0.700	0.643 - 0.720
6	7.87	12.60	9.84	9.84	9.84	0.602 - 0.674	0.736 - 0.825	0.920 - 1.031	0.946 - 1.060
8	9.84	15.35	11.02	11.02	11.02	0.784 - 0.878	0.958 - 1.073	1.198 - 1.342	1.228 - 1.376
10	11.81	18.90	14.57	14.57	14.57	0.977 - 1.094	1.194 - 1.337	1.473 - 1.650	1.536 - 1.720
12	11.81	22.05	15.43	15.43	15.43	1.159 - 1.298	1.417 - 1.587	1.747 - 1.957	1.821 - 2.039
14	11.81	24.80	17.32	17.32	17.32	1.273 - 1.426	1.556 - 1.743	1.918 - 2.148	2.000 - 2.240
16	11.81	27.95	19.57	19.57	19.57	1.455 - 1.630	1.778 - 1.992	2.192 - 2.455	2.286 - 2.560
18	11.81	31.50	22.05	22.05	22.05	1.636 - 1.832	2.00 - 2.240	2.466 - 2.762	2.571 - 2.879
20	11.81	35.43	24.80	24.80	24.80	1.818 - 2.036	2.222 - 2.489	2.740 - 3.069	2.857 - 3.200
22	13.78	27.20	22.09	22.09	22.09	2.000 - 2.240	2.444 - 2.737	3.014 - 3.376	3.143 - 3.520
24	13.78	28.54	23.15	23.15	23.15	2.182 - 2.444	2.667 - 2.987	3.288 - 3.683	3.429 - 3.841
26	13.78	29.88	24.21	24.21	24.21	2.364 - 2.648	2.889 - 3.236	3.562 - 3.989	3.714 - 4.160
28	13.78	31.22	25.31	25.31	25.31	2.545 - 2.850	3.111 - 3.484	3.836 - 4.296	-
30	15.75	34.33	27.83	27.83	27.83	2.727 - 3.054	3.333 - 3.733	-	-
32	15.75	35.67	28.90	28.90	28.90	2.909 - 3.258	3.556 - 3.983	-	-
34	15.75	37.05	30.00	30.00	30.00	3.091 - 3.462	3.778 - 4.231	-	-
36	15.75	38.39	31.10	31.10	31.10	3.273 - 3.666	-	-	-
42	19.69	45.94	37.20	37.20	37.20	3.818 - 4.276	-	-	-

NOTE:

- ▶ 11.25°/22.5°/30°/60° Elbows are also available upon request.
- ▶ Other angles can also be manufactured as per customer's requirements.
- ▶ e = Thickness at the end.
- ▶ Segmented fittings are also available in 2 segments upon request.
- ▶ The tolerance limit for the angle (α) will be ±2°.
- ▶ Refer to FM & WRAS certificates for more information.

# Segmented Fittings

(Imperial)

## Equal Tee (ANSI/AWWA C906):

SD-PESET (PE 100/PE 4710 - 3 Segments, Long spigot version)

d <sub>n</sub>	L <sub>o</sub>	Z1	Z2	L	e			
					DR 11	DR 9	DR 7.3	DR 7
					PC200	PC250	PC317	PC335
Inch	Min Inch	Min Inch	Min Inch	Min Inch	Inch	Inch	Inch	Inch
4	5.91	8.27	8.27	16.54	0.409 - 0.458	0.500 - 0.560	0.625 - 0.700	0.643 - 0.720
6	7.87	11.42	11.42	22.83	0.602 - 0.674	0.736 - 0.825	0.920 - 1.031	0.946 - 1.060
8	9.84	14.17	14.17	28.35	0.784 - 0.878	0.958 - 1.073	1.198 - 1.342	1.228 - 1.376
10	11.81	17.32	17.32	34.65	0.977 - 1.094	1.194 - 1.337	1.473 - 1.650	1.536 - 1.720
12	11.81	23.62	23.62	47.24	1.159 - 1.298	1.417 - 1.587	1.747 - 1.957	1.821 - 2.039
14	11.81	25.59	25.59	51.18	1.273 - 1.426	1.556 - 1.743	1.918 - 2.148	2.000 - 2.240
16	11.81	27.56	27.56	55.12	1.455 - 1.630	1.778 - 1.992	2.192 - 2.455	2.286 - 2.560
18	11.81	29.53	29.53	59.06	1.636 - 1.832	2.00 - 2.240	2.466 - 2.762	2.571 - 2.879
20	11.81	31.50	31.50	62.99	1.818 - 2.036	2.222 - 2.489	2.740 - 3.069	2.857 - 3.200
22	13.78	32.68	32.68	65.35	2.000 - 2.240	2.444 - 2.737	3.014 - 3.376	3.143 - 3.520
24	13.78	33.46	33.46	66.93	2.182 - 2.444	2.667 - 2.987	3.288 - 3.683	3.429 - 3.841
26	13.78	34.65	34.65	69.29	2.364 - 2.648	2.889 - 3.236	3.562 - 3.989	3.714 - 4.160
28	13.78	35.43	35.43	70.87	2.545 - 2.850	3.111 - 3.484	3.836 - 4.296	-
30	15.75	38.58	38.58	77.17	2.727 - 3.054	3.333 - 3.733	-	-
32	15.75	39.57	39.57	79.13	2.909 - 3.258	3.556 - 3.983	-	-
34	15.75	40.55	40.55	81.10	3.091 - 3.462	3.778 - 4.231	-	-
36	15.75	41.73	41.73	83.46	3.273 - 3.666	-	-	-
42	19.69	48.43	48.43	96.85	3.818 - 4.276	-	-	-

**NOTE:**

- ▶ The tolerance limit for the angle (α) will be ±2°.
- ▶ e = Thickness at the end.
- ▶ Refer to FM & WRAS certificates for more information.

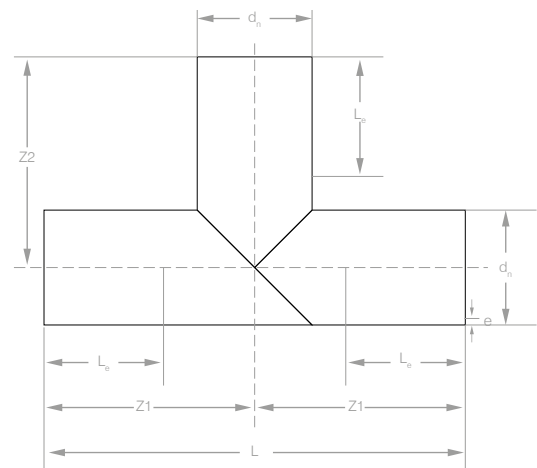

Equal Tee



# Segmented Fittings

(Imperial)



## Reducer Tee (ANSI/AWWA C906):

SD-PESRT (PE 100/PE 4710 - 2 Segments, Long spigot version)

D x d <sub>n</sub>	D	d <sub>n</sub>	L	L1	e1				e2			
					DR 11 PC200	DR 9 PC250	DR 7.3 PC317	DR 7 PC335	DR 11 PC200	DR 9 PC250	DR 7.3 PC317	DR 7 PC335
Inch	Inch	Inch	Min Inch	Min Inch	Inch	Inch	Inch	Inch	Inch	Inch	Inch	Inch
10 x 4	10	4	28.35	11.81	0.977 - 1.094	1.194 - 1.337	1.473 - 1.650	1.536 - 1.720	0.409 - 0.458	0.500 - 0.560	0.625 - 0.700	0.643 - 0.720
12 x 6	12	6	28.35	11.81	1.159 - 1.298	1.417 - 1.587	1.747 - 1.957	1.821 - 2.039	0.602 - 0.674	0.736 - 0.825	0.920 - 1.031	0.946 - 1.060
14 x 4	14	4	28.35	11.81	1.273 - 1.426	1.556 - 1.743	1.918 - 2.148	2.000 - 2.240	0.409 - 0.458	0.500 - 0.560	0.625 - 0.700	0.643 - 0.720
14 x 6	14	6	28.35	11.81	1.273 - 1.426	1.556 - 1.743	1.918 - 2.148	2.000 - 2.240	0.602 - 0.674	0.736 - 0.825	0.920 - 1.031	0.946 - 1.060
16 x 6	16	6	28.35	11.81	1.455 - 1.63	1.778 - 1.992	2.192 - 2.455	2.286 - 2.560	0.602 - 0.674	0.736 - 0.825	0.920 - 1.031	0.946 - 1.060
16 x 8	16	8	28.35	11.81	1.455 - 1.63	1.778 - 1.992	2.192 - 2.455	2.286 - 2.560	0.784 - 0.878	0.958 - 1.073	1.198 - 1.342	1.228 - 1.376
18 x 8	18	8	28.35	11.81	1.636 - 1.832	2.000 - 2.240	2.466 - 2.762	2.571 - 2.879	0.784 - 0.878	0.958 - 1.073	1.198 - 1.342	1.228 - 1.376
20 x 6	20	6	28.35	11.81	1.818 - 2.036	2.222 - 2.489	2.740 - 3.069	2.857 - 3.200	0.602 - 0.674	0.736 - 0.825	0.920 - 1.031	0.946 - 1.060
20 x 8	20	8	28.35	11.81	1.818 - 2.036	2.222 - 2.489	2.740 - 3.069	2.857 - 3.200	0.784 - 0.878	0.958 - 1.073	1.198 - 1.342	1.228 - 1.376
20 x 10	20	10	28.35	11.81	1.818 - 2.036	2.222 - 2.489	2.740 - 3.069	2.857 - 3.200	0.977 - 1.094	1.194 - 1.337	1.473 - 1.650	1.536 - 1.720

NOTE:

- ▶ e1 & e2 = Thickness at the end.
- ▶ Refer to FM & WRAS certificates for more details.

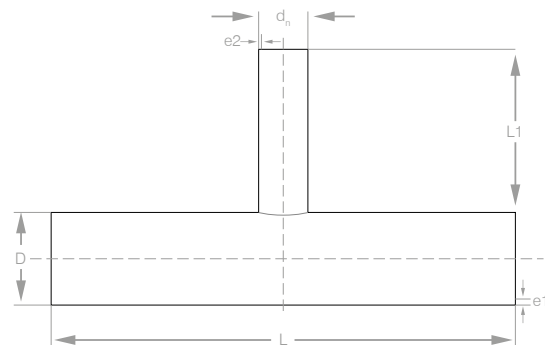

Reducer Tee



# Segmented Fittings

(Imperial)

## Cross Tee (ANSI/AWWA C906):

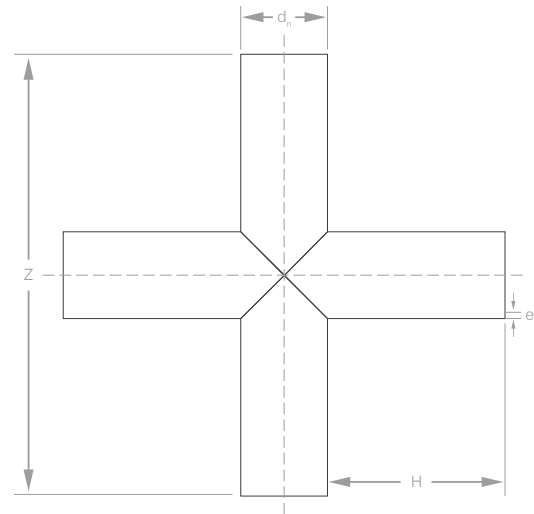

Cross Tee

## SD-PESCT (PE 100/PE 4710 - 4 Segments, Long spigot version)

d <sub>n</sub>	O.D.	Z	H	e			
				DR 11 PC200	DR 9 PC250	DR 7.3 PC317	DR 7 PC335
Inch	Inch	Min Inch	Min Inch	Inch	Inch	Inch	Inch
4	4.50	11.00	3.000	0.409 - 0.458	0.500 - 0.560	0.625 - 0.700	0.643 - 0.720
6	6.63	12.00	4.000	0.602 - 0.674	0.736 - 0.825	0.920 - 1.031	0.946 - 1.060
8	8.63	26.50	6.000	0.784 - 0.878	0.958 - 1.073	1.198 - 1.342	1.228 - 1.376
10	10.75	31.75	7.500	0.977 - 1.094	1.194 - 1.337	1.473 - 1.650	1.536 - 1.720
12	12.75	30.00	8.625	1.159 - 1.298	1.417 - 1.587	1.747 - 1.957	1.821 - 2.039
14	14.00	33.00	9.500	1.273 - 1.426	1.556 - 1.743	1.918 - 2.148	2.000 - 2.240
16	16.00	36.00	10.000	1.455 - 1.630	1.778 - 1.992	2.192 - 2.455	2.286 - 2.560
18	18.00	40.00	11.000	1.636 - 1.832	2.00 - 2.240	2.466 - 2.762	2.571 - 2.879
20	20.00	52.00	16.000	1.818 - 2.036	2.222 - 2.489	2.740 - 3.069	2.857 - 3.200
22	22.00	52.00	15.000	2.000 - 2.240	2.444 - 2.737	3.014 - 3.376	3.143 - 3.520
24	24.00	54.00	15.000	2.182 - 2.444	2.667 - 2.987	3.288 - 3.683	3.429 - 3.841

NOTE:

► e = Thickness at the end.



# HDPE

## fitting accessories



SHIELD provides state-of-the-art fitting accessories for joining HDPE piping system which not only ensures the safe conveyance but also makes it possible to easily move HDPE pipes at a later stage.

NOTE: Please contact us for more information.

# Fitting Accessories



## Galvanized Backing Ring (BS 4504/EN 1092-1): (for HDPE Stub Flange Adaptor)

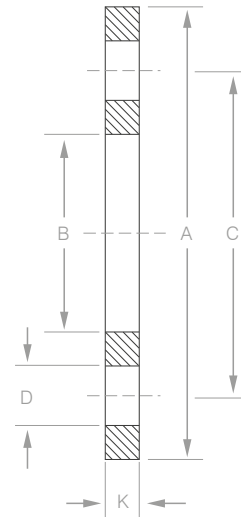

Galvanized Backing Ring

## SD-GBKR-16 (as per BS 4504/EN 1092-1 PN16)

HDPE Pipe Size		d <sub>n</sub> mm	Outer Diameter A mm	Internal Diameter B mm	PCD C mm	Hole Diameter D mm	No. of Holes	Thickness K mm
SDR mm	DR Inch							
50	1½	40	150	63	110	18	4	18
63	2	50	165	79	125	18	4	19
75	2½	65	185	93	145	18	8	20
90	3	80	200	110	160	18	8	20
110	4	100	220	128	180	18	8	22
125	-	125	250	135	210	18	8	22
160	6	150	285	178	240	22	8	24
180	-	150	285	188	240	22	8	24
200	8	200	340	236	295	22	12	26
225	-	200	340	238	295	22	12	26
250	10	250	405	290	355	26	12	29
280	-	250	405	294	355	26	12	29
315	12	300	460	338	410	26	12	32
355	14	350	520	376	470	26	16	35
400	16	400	580	430	525	30	16	38
450	18	450	640	518	585	30	20	42
500	20	500	715	535	650	33	20	46

NOTE:

- ▶ Backing Ring is also available in Polypropylene (PP) coating upon request.
- ▶ Backing Rings have been modified as per the requirements of HDPE sizes.
- ▶ Refer to FM certificate for more information.



# Fitting Accessories

## Stainless Steel Backing Ring (BS 4504/EN 1092-1): (for HDPE Stub Flange Adaptor)

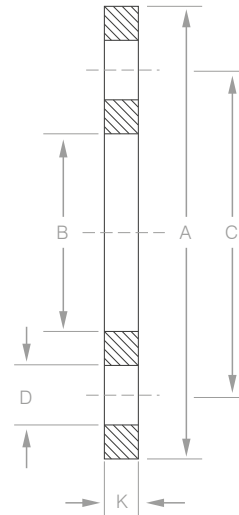

SS Backing Ring

SD-SSBKR (as per BS 4504/EN 1092-1 PN16)

HDPE Pipe Size		d <sub>n</sub> mm	Outer Diameter A mm	Internal Diameter B mm	PCD C mm	Hole Diameter D mm	No. of Holes	Thickness K mm
SDR mm	DR Inch							
20	¼	15	95	28	65	14	4	14
25	½	20	105	34	75	14	4	16
32	1	25	115	42	85	14	4	18
40	1¼	32	140	51	100	18	4	18
50	1½	40	150	63	110	18	4	18
63	2	50	165	79	125	18	4	19
75	2½	65	185	93	145	18	8	20
90	3	80	200	110	160	18	8	20
110	4	100	220	128	180	18	8	22
125	-	125	250	135	210	18	8	22
160	6	150	285	178	240	22	8	24
180	-	150	285	188	240	22	8	24
200	8	200	340	236	295	22	12	26
225	-	200	340	238	295	22	12	26
250	10	250	405	290	355	26	12	29
280	-	250	405	294	355	26	12	29
315	12	300	460	338	410	26	12	32
355	14	350	520	376	470	26	16	35
400	16	400	580	430	525	30	16	38
450	18	450	640	518	585	30	20	42
500	20	500	715	535	650	33	20	46

NOTE:

- ▶ SS Backing Ring is available in SS304 and SS316.
- ▶ PP/Steel are also available upon request.

# Fitting Accessories



## Steel Blind Flange (BS 4504/EN 1092-1):

(for HDPE Stub Flange Adaptor)

SD-BF-16 (as per BS 4504/EN 1092-1 PN16)

HDPE Pipe Size		d <sub>n</sub> mm	Outer Diameter A mm	PCD C mm	Hole Diameter D mm	No. of Holes	Thickness K mm
SDR mm	DR Inch						
50	1½	40	150	110	18	4	16
63	2	50	165	125	18	4	18
75	2½	65	185	145	18	8	18
90	3	80	200	160	18	8	20
110	4	100	220	180	18	8	20
125	-	125	250	210	18	8	22
160	6	150	285	240	22	8	22
180	-	150	285	240	22	8	22
200	8	200	340	295	22	12	24
225	-	200	340	295	22	12	24
250	10	250	405	355	26	12	26
280	-	250	405	355	26	12	26
315	12	300	460	410	26	12	28
355	14	350	520	470	26	16	30
400	16	400	580	525	30	16	32
450	18	450	640	585	30	20	34
500	20	500	715	650	33	20	36

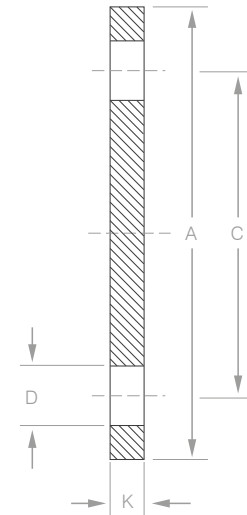

Steel Blind Flange

**NOTE:**

- ▶ Steel Blind Flanges have been modified as per the requirements of HDPE sizes.
- ▶ Refer to FM certificate for more information.



# Fitting Accessories

## Galvanized Backing Ring (ANSI/ASME B16.5):

(for HDPE Stub Flange Adaptor)

SD-GBKR-150 (as per ANSI/ASME B16.5 Class 150)

HDPE Pipe Size		d <sub>n</sub> mm	Outer Diameter A mm	Internal Diameter B mm	PCD C mm	Hole Diameter D mm	No. of Holes	Thickness K mm
SDR mm	DR Inch							
50	1½	40	125	63	98.4	15.87	4	17.5
63	2	50	150	79	120.7	19.05	4	19.1
75	2½	65	180	93	139.7	19.05	4	22.3
90	3	80	190	110	152.4	19.05	4	23.9
110	4	100	230	128	190.5	19.05	8	23.9
125	-	125	255	135	215.9	19.05	8	23.9
160	6	150	280	178	241.3	22.22	8	25.4
180	-	150	280	188	241.3	22.22	8	25.4
200	8	200	345	236	298.5	22.22	8	28.6
225	-	200	345	238	298.5	22.22	8	28.6
250	10	250	405	290	362.0	25.40	12	30.2
280	-	250	405	294	362.0	25.40	12	30.2
315	12	300	485	338	431.8	25.40	12	31.8
355	14	350	535	376	476.3	28.57	12	35.0
400	16	400	595	430	539.8	28.57	16	36.6
450	18	450	635	518	577.9	31.75	16	39.7
500	20	500	700	535	635.0	31.75	20	42.9

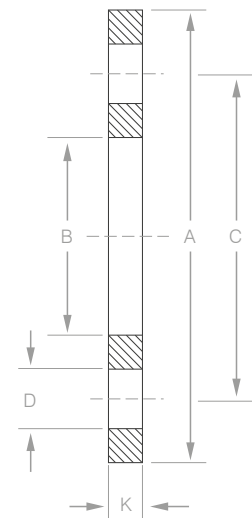

Galvanized Backing Ring

**NOTE:**

- ▶ Backing Ring is also available in Polypropylene (PP) coating upon request.
- ▶ Backing Rings have been modified as per the requirements of HDPE sizes.
- ▶ Refer to FM certificate for more information.



# Fitting Accessories

## Stainless Steel Backing Ring (ANSI/ASME B16.5): (for HDPE Stub Flange Adaptor)

SD-SSBKR-150 (as per ANSI/ASME B16.5 Class 150)

d <sub>n</sub>	Outer Diameter	Internal Diameter	PCD	Hole Diameter	No. of Holes	Thickness
	A	B	C	D		
Inch	mm	mm	mm	mm	mm	mm
1½	125	63	98.4	15.87	4	15.9
2	150	79	120.7	19.05	4	17.5
2½	180	93	139.7	19.05	4	20.7
3	190	110	152.4	19.05	4	22.3
4	230	128	190.5	19.05	8	22.3
5	255	135	215.9	19.05	8	22.3
6	280	178	241.3	22.22	8	23.9
8	345	236	298.5	22.22	8	27.0
10	405	290	362.0	25.40	12	28.6
12	485	338	431.8	25.40	12	30.2
14	535	376	476.3	28.57	12	33.4
16	595	430	539.8	28.57	16	35.0
18	635	518	577.9	31.75	16	38.1
20	700	535	635.0	31.75	20	41.3
24	815	620	749.3	34.92	20	47.7

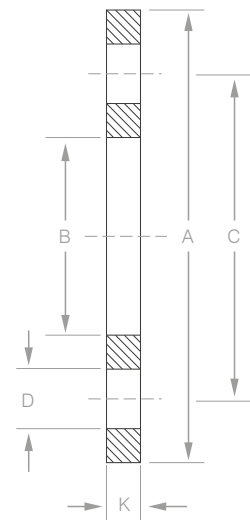

SS Backing Ring

NOTE:

- ▶ SS Backing Ring is available in SS304 and SS316.
- ▶ PP/Steel are also available upon request.



# Fitting Accessories

## Steel Blind Flange (ANSI/ASME B16.5):

(for HDPE Stub Flange Adaptor)

SD-BF-150 (as per ANSI/ASME B16.5 Class 150)

HDPE Pipe Size		d <sub>n</sub> mm	Outer Diameter A mm	PCD C mm	Hole Diameter D mm	No. of Holes mm	Thickness K mm
SDR mm	DR Inch						
50	1½	40	125	98.4	15.87	4	17.5
63	2	50	150	120.7	19.05	4	19.1
75	2½	65	180	139.7	19.05	4	22.3
90	3	80	190	152.4	19.05	4	23.9
110	4	100	230	190.5	19.05	8	23.9
125	-	125	255	215.9	19.05	8	23.9
160	6	150	280	241.3	22.22	8	25.4
180	-	150	280	241.3	22.22	8	25.4
200	8	200	345	298.5	22.22	8	28.6
225	-	200	345	298.5	22.22	8	28.6
250	10	250	405	362.0	25.40	12	30.2
280	-	250	405	362.0	25.40	12	30.2
315	12	300	485	431.8	25.40	12	31.8
355	14	350	535	476.3	28.57	12	35.0
400	16	400	595	539.8	28.57	16	36.6
450	18	450	635	577.9	31.75	16	39.7
500	20	500	700	635.0	31.75	20	42.9

**NOTE:**

- ▶ Steel Blind Flanges have been modified as per the requirements of HDPE sizes.
- ▶ Refer to FM certificate for more information.

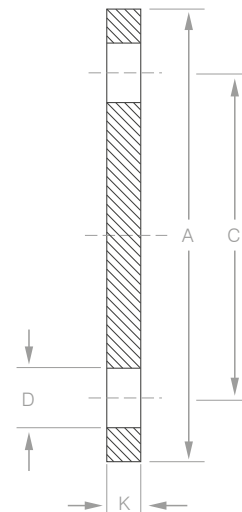

Steel Blind Flange



# Fitting Accessories

## EPDM Rubber - Gasket:

(for HDPE Stub Flange Adaptor)

SD-RGKT

$d_n$ mm	$\varnothing$ mm	A mm	B mm	S mm
25	32	68	28	3
32	40	78	36	3
40	50	88	44	3
50	63	102	54	3
65	75	122	53	3
80	90	138	76	3
100	110	158	92	3
100	125	158	104	3
125	140	188	116	3
150	160	212	134	3
150	180	212	150	3
200	200	268	166	3
200	225	268	188	3
250	250	320	207	3
250	280	320	233	3
300	315	370	260	3
350	355	430	294	3
400	400	482	330	4
450	450	535	372	4
500	450	585	372	4
500	500	585	446	4
600	560	685	500	4
600	630	685	562	4
700	710	800	632	4
800	800	900	710	4
900	900	1005	830	4
1000	1000	1110	944	4
1200	1200	1330	1108	4

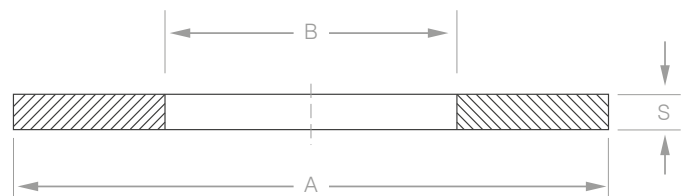

EPDM Rubber - Gasket

NOTE:

- ▶ EPDM Rubber Gasket have been modified as per the requirements of HDPE sizes.





# Electro











## Fusion fittings



SHIELD also supplies state-of-the-art electrofusion fittings for various applications.

NOTE: Please contact us for more information.

# Electro-Fusion Fittings

Product Image	S.No	Description	Size Range	Available
	1	Couplers	20 mm - 400 mm	PE 100 Black
	2	90° Elbows	20 mm - 200 mm	PE 100 Black
	3	45° Elbows	20 mm - 200 mm	PE 100 Black
	4	Tees	20 mm - 200 mm	PE 100 Black
	5	Reducers	20 mm - 200 mm	PE 100 Black
	6	20/32/40/50/63mm Top Loading Branch Saddle	40 mm - 250 mm	PE 100 Black
	7	20/32/40/50/63mm Top Loading Tapping Tees	40 mm - 250 mm	PE 100 Black
	8	Under Clamping Tapping Tees - Monobloc version	40 mm - 110 mm	PE 100 Black
	9	Branch Saddle - Monobloc version	40 mm - 110 mm	PE 100 Black
	10	End Cap	20 mm - 180 mm	PE 100 Black
	11	Male Transition Socket	20 mm - 110 mm	PE 100 Black
	12	Female Transition Socket	20 mm - 110 mm	PE 100 Black



# Electro-Fusion Fittings

Product Image	S.No	Description	Size Range	Available
	13	Transition Adaptor, PE / Brass, Male BSP Taper	20 mm - 110 mm	PE 100 Black
	14	Transition Adaptor, PE / Brass, Female BSP Taper	20 mm - 110 mm	PE 100 Black
	15	90° Transition Elbow, PE / Brass, Male BSP Taper	20 mm - 110 mm	PE 100 Black
	16	90° Transition Elbow, PE / Brass, Female BSP Taper	20 mm - 110 mm	PE 100 Black
	17	45° Transition Elbow, PE / Brass, Male BSP Taper	20 mm - 110 mm	PE 100 Black
	18	45° Transition Elbow, PE / Brass, Female BSP Taper	20 mm - 110 mm	PE 100 Black
	19	Transition Socket, PE / Brass - Free Nut	20 mm - 63 mm	PE 100 Black
	20	90° Transition Elbow, PE / Brass - Free Nut	20 mm - 63 mm	PE 100 Black
	21	45° Transition Elbow, PE / Brass - Free Nut	32 mm - 63 mm	PE 100 Black
	22	Transition Spigot Saddle, PE / Brass	110 mm - 160 mm	PE 100 Black
	23	Spigot Saddle, PE / Brass - Shut-off Equipment	110 mm - 160 mm	PE 100 Black

# Fusing

solutions for HDPE  
Pipes & Fittings



# Fusion Machines

SHIELD supplies fusion machines for the jointing of HDPE pipes and fittings. All the fusion machines are designed and built according to International standards.

## Butt-Fusion Machines:

For jointing HDPE pipes it is the most common method used for pipes to be jointed, having bigger diameters (larger than 90mm) for many reasons including cost, simplicity, strength of joints, etc.

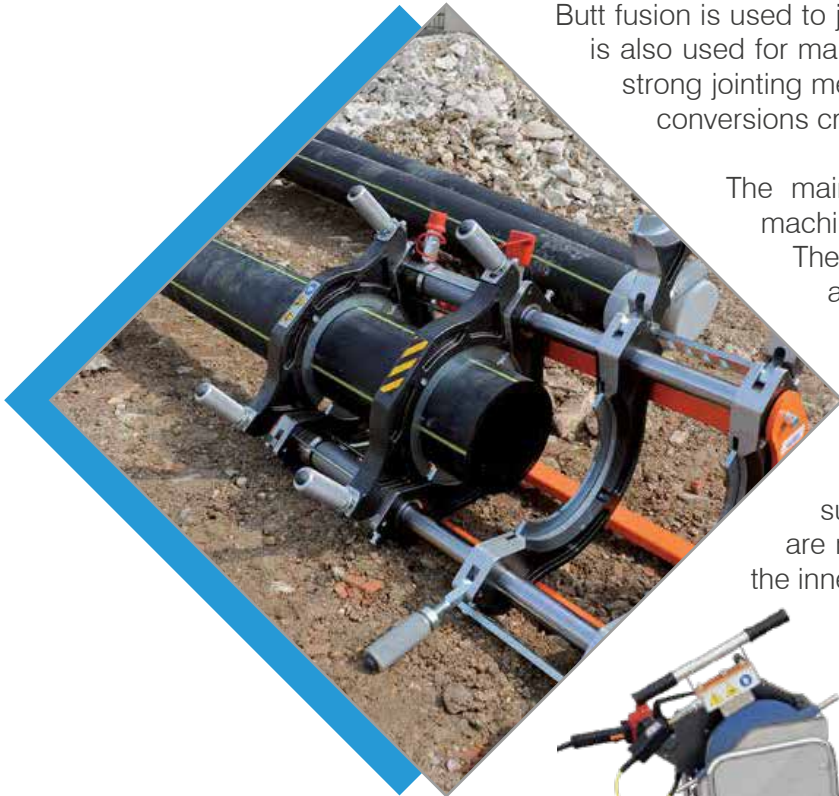

Butt fusion is used to joint pipes with one another or with the fittings. It is also used for manufacturing segmented fittings. This reliable and strong jointing method withstands the pressure changes and flow conversions critical pressure performance.

The main parts of a butt-fusion machine consists of machine body, hydraulic unit, heater and milling cutter. The clamps are used to fasten the pipes firmly and assure they will not move or slip during the welding process.

If the pipe diameter is smaller than clamps, then it will be necessary to use inserts to make sure that pipe will be firmly fastened. These inserts are metal parts in the shape of arcs that are fixed in the inner periphery of the clamps.

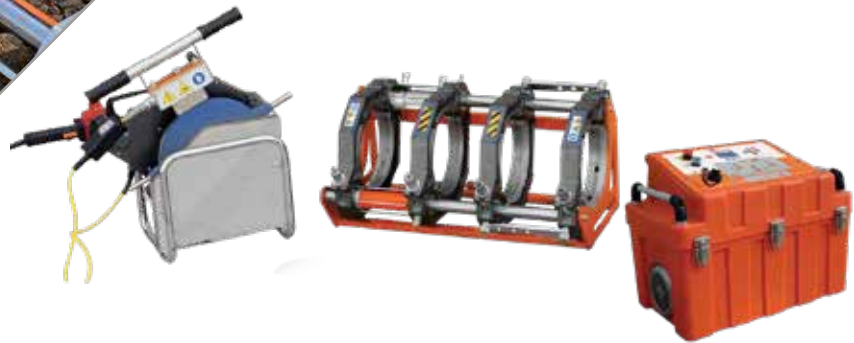

## Facts & Benefits of Butt-Fusion:

- ▶ Visual inspection is possible during the welding process.
- ▶ Uniform heating and melting under pressure makes the joint stronger and durable.
- ▶ Jointing of pipes and fittings of different SDRs are not advisable.
- ▶ Proper heating and cooling before and after jointing is important for getting the best results.
- ▶ Butt-fusion joints make pipe system stronger due to formation of beads during the welding process.
- ▶ Beads formed during butt-fusion states the quality of jointing.
- ▶ HDPE pipe fused joints are self-restraining and usually do not require thrust blocks which also nullifies the probability of water leakage.
- ▶ Using a butt-fusion method does not only eliminate the requirements of extra material or support but also gives a cost-effective and long-life solution.

# Fusion Machines

## Range of Butt-Fusion Machines:

SHIELD provides wide range of Butt-Fusion Machines which are manual, semi-automatic and fully automatic machines to fulfil project requirements ranging from:

- ▶ Basic Line: Set of machines (160 to 355) covers pipe diameters from 40mm to 355mm. Basic line machines are Manually operated hydraulic machines.
- ▶ Basic Easy life: Set of machines (160 to 355) covers pipe diameters from 40mm to 355mm. Basic Easy line machines are Semi-automatic hydraulic machines capable of storing and retrieving welding information to get joint reports.
- ▶ Delta Line: Set of machines (500 to 1600) covers pipe diameters from 200mm to 1600mm. DELTA line machines are self aligning hydraulic machines.
- ▶ Delta Easy life: Set of machines (500 to 630) covers pipe diameters from 200mm to 630mm. Delta Easy line machines are Semi-automatic hydraulic machines capable of storing and retrieving welding information to get joint reports.
- ▶ All Terrain-Trailer Line & CNC machines are also available upon request.

## General Technical Details:

<b>Working Range:</b>	40 mm to 1600 mm	<b>Power Supply:</b>	110 V Single Phase 50/60 Hz 230 V Single Phase 50/60 Hz 400 V Three Phase 50/60 Hz
<b>Materials:</b>	HDPE, PP, PP-R, PB, PVDF <small>* Contact SHIELD for different materials</small>	<b>Working Temperature:</b>	180°C - 280°C
<b>Total Absorbed Power:</b>	2400 W - 45000 W	<b>Outside Temperature Range:</b>	-10°C - 40°C
<b>Weight Machine Body:</b>	21 Kg - 4800 Kg		

## Standard Composition of Machine:



# Fusion Machines

## Range of Electro-Fusion Machines:

SHIELD provides wide range of Electro-Fusion Machines which includes mainly:

- ▶ Elektra 500
- ▶ Elektra 1000

General Technical Details:

<b>Working Range:</b>	20 - 500 mm to 20 - 1600 mm	<b>Welding Output Voltage:</b>	8 - 48 V
<b>Materials:</b>	HDPE, PP, PP-R	<b>Power Supply:</b>	110 V Single Phase 50/60 Hz 230 V Single Phase 50/60 Hz
<b>Max. Absorbed Power:</b>	3100 W (110 V) 3500 W (230 V)	<b>60% Duty Cycle Output 2:</b>	70 A - 90 A
<b>Connections:</b>	USB for external memory and ESC-POS	<b>Operating Mode:</b>	Bar-code Manual (Numerical code or tension/time)
<b>Max. Output Current:</b>	100 A (110 V) 120 A (230 V)	<b>Outside Temperature Range:</b>	-10°C - 50°C
<b>Protection Degree:</b>	IP 54	<b>T°Reading Probe-precision:</b>	± 1°C
<b>Memory:</b>	4000 Reports	<b>Dimensions Transport Case:</b>	± 1°410 x 290 x 485 mm
<b>Welding Hose Length:</b>	3m	<b>Weight Standard Composition:</b>	18 Kg - 20 Kg

Standard Composition of Machine:





# Tools & machine accessories for proper fusion welding



Wide range of tools, accessories and spares are available to prepare HDPE pipes & fittings for proper fusion welding. It is important to use proper tools and accessories to execute professional quality welded joint.

# Machine Accessories



## The Inspector:

It controls, records and generates a PDF report of the entire welding process.



## Pipe Scrappers:

It is essential to prepare the plastic pipes and fittings before Electro-Fusion welding. Practical and handy, the pipe scrappers remove the oxidation layer caused by weather and ultraviolet rays.



## Universal Aligners:

This tool is used to hold the pipes still and aligned during Electro-Fusion.



## Pipe Aligners:

It is an essential and a professional tool for the alignment and support of pipes during Electro-Fusion from Ø 125 mm to 500 mm.



## Rollers:

This device is essential for supporting the pipes while they are being welded with the butt fusion machines. The roller minimizes pipe friction and drag force independently of the jobsite conditions.



## Pipe Cutters:

It is a professional tool, essential for the manual cut of plastic pipes up to Ø 315 mm.

# HDPE Installation Manual





# Installation Manual

## Joining Methods:

Safety considerations are very important when joining the high density polyethylene piping material, but they are not a part of this document; the user of this joining information must consult and follow the appropriate safety instructions, please refer to the Health and Safety section.

For permanent Joints (FUSION)	For Mobile (detachable) Joints (MECHANICAL)
Electro-Fusion welding	Flanged Joints
Butt-Fusion Welding	Compression Joints
Socket Fusion Welding	Insert Joints
-	Quick release Joints

*No chain is stronger than its weakest link is a common saying which can also be applied to the piping system joints.*

The main requirements to be fulfilled are hydraulic tightness as well as structural stability of the system. An integral part of any piping system is the method used to joint the system components. Proper engineering design of a system will take into consideration along with the type and effectiveness of techniques used to joint the piping components and appurtenances as well as the durability of the resulting Joints.

The integrity and versatility of the joining techniques used for high density polyethylene pipe allow the designer to take advantage of the performance benefits in a variety of applications.

HDPE pipe and fitting can be assembled into a pipeline network by means of fusion or mechanical assembly techniques depending on the project requirements.

Wide range of fittings are available to cater design flexibility for HDPE piping system.



# Installation Manual

## Heat Fusion Welding (permanent):

The fundamental of heat fusion welding is to apply heat and pressure for a specified time to the mating surfaces to be jointed. The application of heat and pressure under the correct conditions allows changing the resin's molecular structure to an amorphous state and then fuse them together by application of prescribed force until cooling occurs, returning the material to a crystalline state and creating one homogeneous pipe and also creating a joint as strong as the pipe itself. A fusion of HDPE pipe and fittings can be by Electro-Fusion, Butt-Fusion or Socket fusion.



## Electro-Fusion:

Electro-Fusion is a simple method of jointing HDPE pipes in circumstances where butt-fusion is not practicable, such as where valves, elbows and tees must be added.

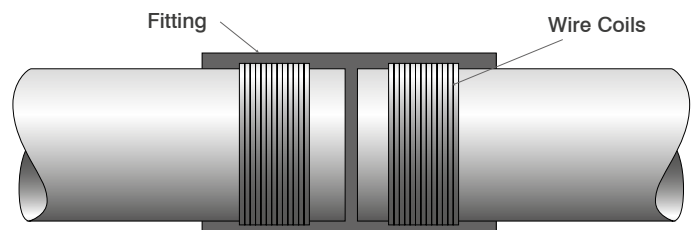

Typical Electrofusion Joint

Electro-Fusion is most commonly used for jointing pipes up to 250mm diameter, but there is no technical upper limit. Different grades and SDR's of pipe can be connected using Electro-Fusion, again only under controlled conditions.

Electro-Fusion fittings may be of different grade and SDR than the pipes, in which case the lower rating (pipe or fitting) governs the rating of the assembly as a whole.

Electro-Fusion is most commonly used in conventional open cut trenching installation, and in repair works. It is also used for adding new services to existing HDPE mains by means of saddle fittings or tees. It is less well suited to trench-less installation or rehabilitation methods because the fittings protrude on the outside of the pipe.

Electro-Fusion fittings are available in a range of forms; they may be straight connectors, bends, tees, stop ends, reducers, saddle fittings and repair fittings.



# Installation Manual

## Butt-Fusion:

This is the simplest and quickest method of jointing HDPE pipes of any diameter. Butt fusion is a thermo-fusion process which involves the simultaneous heating of the ends of two pipe/fitting components which are to be jointed, until a molten state is attained on each contact surface. The two surfaces are then brought together under controlled pressure for a specific cooling time and a homogeneous fusion joint is formed. The resultant joint is fully resistant to end loads and has comparable performance under pressure to the pipe itself.

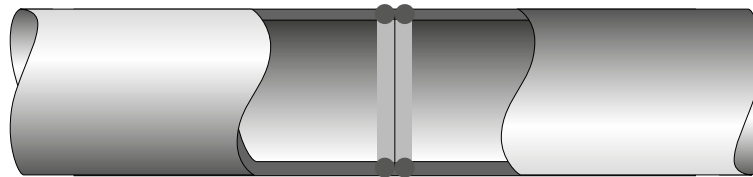

Schematic Butt Fusion Joint



An electrical heater plate is used to raise the temperature of the pipe ends to the required fusion temperature. The butt welding machines have controls to ensure the welding parameters.

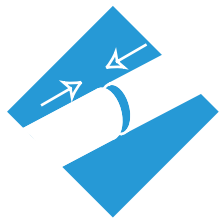

Used for jointing pipes and fittings from 90mm diameter to larger. However, it is most commonly used for larger diameter pipes. Butt fusion jointing is equally suited for both coiled and straight pipe lengths.

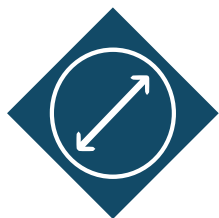

Only pipes and fittings of the same nominal diameter and SDR should be butt fused.

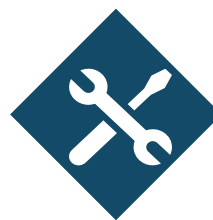

Due to the low profile of the butt joint, it is ideal for use in Trenchless technology installations; slip-lining, pipe bursting, directional drilling, etc.

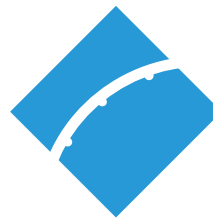

During the fusion process internal and external 'weld beads' are formed, however, as they do not add anything to the overall strength they may be safely removed if required.



Inside beads may create minor flow turbulence of liquids or may become an obstacle on which solids in the fluids may become lodged. Furthermore, outside beads may be a hindrance to slip-lining operations.

### CAUTION



Proper torquing of bolts of the machine is required to obtain specified performance.

- ▶ Insufficient melt bead may result from an improper fusion joint.
- ▶ Butt fusion Joints are stronger when the melt beads remain intact.
- ▶ Butt fusion can also be used to fabricate a range of fittings, bends, tees, reducers, etc.

# Installation Manual

## Socket Fusion Joints:

Welding of HDPE pipes by socket fusion fittings where the individual pipe lengths are jointed by heat fusing the outside surface of the pipe to the inside surface of the fitting thus providing a homogeneous joint and is mainly used for smaller diameter range of domestic plumbing applications.

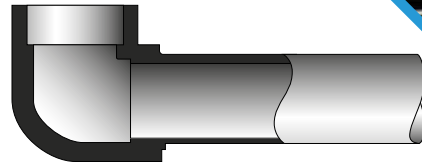

## Mechanical Assembly:

Mechanical assembly is used for jointing where neither fusion method is suitable. Most commonly this is when HDPE and other pipe materials are being connected or when HDPE pipe is connected to valves or similar appurtenances made from other materials or in situations requiring frequent dismantling and shifting.

Mechanical assembly requires the use of fittings, generally working on the compression principle, to joint different materials together. Usually an elastomeric sealing ring is provided for pressure integrity, leak tightness and resistance to end loads. Mechanical fittings generally include a stiffener which is placed inside the pipe or fitting to ensure stability when the fitting is compressed. These stiffeners are also designed to withstand end loading where necessary. The fittings also include gaskets which are compressed to effect the seal at the rated pressure of the fitting.

The fittings, which are used in gas and water applications may differ and it is essential to use the correct fitting for the application. If there is any doubt then the manufacturer should be contacted. Similarly the manufacturer's recommendations on installing the fitting, including any limitations on torque to be applied in tightening the fitting, should be followed at all times.

Mechanical jointing may be used to connect different grades and SDR's, with the same limitations as above for the Electro-Fusion method. Special care should be taken to use the appropriate insert stiffeners to the corresponding SDR.

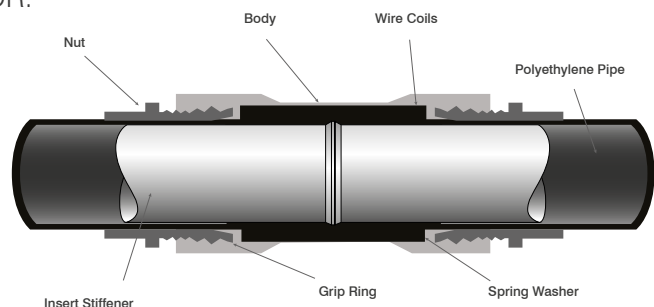

The most widely used mechanical jointing methods include:

**Flanged Joints (with Stub Flanges and Backing Plates)** - HDPE pipes can be flange-jointed by using HDPE stub flange ends in conjunction with metal backing plates and a sealing gasket to provide a demountable joint or to match up with pumps, valves etc.

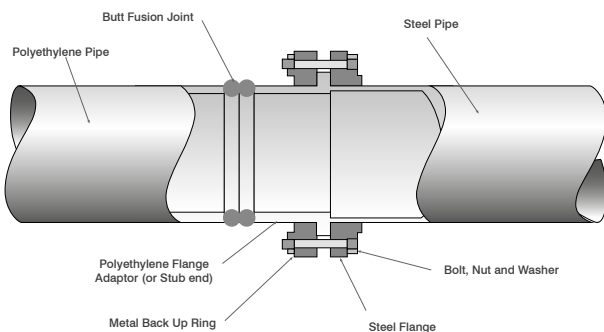

**Compression Joints** - Compression couplers are ideal for pipe systems requiring frequent dismantling and shifting, e.g. economic irrigation of larger areas by using smaller pipe lengths.

### NOTE:

- ▶ Dissimilar materials (PE 100 & PE 80) and dissimilar wall thickness (SDR & DR) can be jointed by Electro-Fusion fittings.
- ▶ Only similar materials (PE 100 or PE 80) and same wall thickness (SDR or DR) can be jointed by Butt-Fusion.
- ▶ Dissimilar wall thickness (SDR or DR) may not be jointed by Butt-Fusion.
- ▶ Dissimilar materials (PE 100, PE 80) may not be jointed by Butt-Fusion.

# Installation Manual

## Installation Procedures:

Polyethylene is a thermoplastic material that when extruded produces a pipe of a flexible nature and to which the principles of flexible pipeline design must be applied not only at the design stage but throughout installation as well.

In particular, the quality of materials and workmanship employed in trench preparation, bedding, backfilling and compaction must be of a high standard, if the full strength potential of the pipeline is to be achieved and pipe deformation limited to that calculated by the design engineer.

The following subsections deal with trench preparation, bedding, backfill and compaction.



### Site Conditions:

For each pipeline development, consideration must first be given to the nature of the site in terms of configuration, existing surface material and the likely subsoil component materials.

- ▶ The machinery and equipment necessary to carry out the work
- ▶ The method of installation (i.e. by trenching or guided drilling)
- ▶ The need of imported material for bedding and surrounds
- ▶ The requirements in respect of the surface restoration.

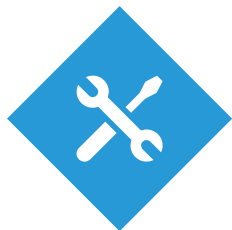

### Installation Methods:

Slip Lining and Pipe Bursting are both proven methods for the rehabilitation of existing clay, metal, and concrete for water and sewer lines.

Directional Drilling of HDPE for water and sewer applications has become popular because of reduced restoration costs and efficiencies of installation.

Trenching is another construction method that allows for greater production efficiencies for the proper application.

Generally the width of the trench should be the minimum dimension compatible with safe working and the satisfactory laying, jointing and bedding of the pipe.

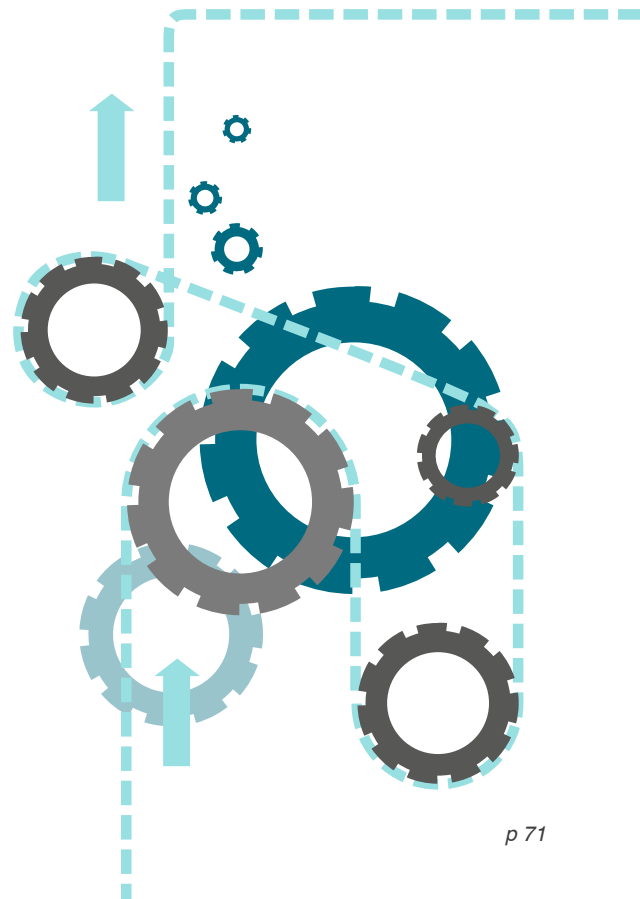

# Above & Underground Piping Solution

# Installation Manual

## Underground Installation of HDPE Piping:

HDPE piping is considered “flexible” pipe. Flexible pipes can deflect up to their allowable deflection limit without damage. Flexibility is directly proportional to the Dimension Ratio (DR). Low DR pipes such as DR 7.3 have high resistance to deflection because their flexibility is very low, or conversely their stiffness is high. The depth of cover and anticipated surface loads also affects the particular installation requirements.

### Allowable Deflection:

HDPE pipes installed on a curved alignment must be drawn evenly over the entire curve length, and not over a short section. This can lead to kinking in small diameter, and/or thin wall pipes. Pegs or stakes are not permitted to achieve the pipeline curvature as these can result in highly localised stresses. Instead, the pipe should be progressively supported by backfill material as the curve is formed.

Large diameter HDPE pipes (450mm and above) must be jointed together, and then drawn evenly to the desired radius. Care must be exercised during construction to prevent over stressing of Joints and fittings. Where mechanical Joints are used, any joint deflection limitations must be observed. During installation, the minimum allowable bending radius, as shown below, should be observed. For curves of smaller radius, post formed bends or moulded fittings shall be used.



The allowable radii of curvature depends on the temperature of the pipe and the SDR. The following table gives recommended minimum bending radius for pipes at 20°C.

Pipe SDR	Minimum Bending Radius (x DN)
9	12
11	15
13.6	21
17/17.6	25
21	35
26	45
33	65

# Installation Manual

In general, there are two objectives to achieve in an installation. The first is to provide an envelope of embedment to protect the pipe from mechanical damage and from the impact of hard objects (pebbles, boulders) in the soil. The second is to provide support against earth and live load pressures, where this is required. The envelope surrounding the pipe is referred to as the "embedment" (see *Underground Piping Installation Diagram*). The earth and live loads are supported by the combination of

the pipe stiffness and the embedment stiffness. Lower SDR pipes will carry more of the load and require less support from the soil. When support from the embedment is needed by the pipe to resist earth and live loads, the embedment material is often compacted. The trench backfill placed on top of the embedment material may also be compacted. Compaction of trench backfill immediately above the pipe facilitates the redistribution of some of the load away from the pipe and into the side-fill soil.

## 1. Foundation:

A foundation is required only when the native trench bottom does not provide a firm working platform for placement of the pipe bedding material.

## 3. Bedding:

In addition to bringing the trench bottom to required grade, the bedding levels out any irregularities and ensures uniform support along the length of the pipe.

## 4. Haunch:

The backfill under the lower half of the pipe (haunches) distributes the superimposed loadings. The nature of the haunch material and the quality of its placement are one of the most important factors in limiting the deformation of HDPE pipe.

## 5. Primary Initial Backfill:

This zone of backfill provides the primary support against lateral pipe deformation. To ensure such support is available, this zone should extend from the trench grade up to at least 75 percent of the pipe diameter. Under some conditions, such as when the pipe will be permanently below the ground water table, the primary initial backfill should extend to at least 6 inches over the pipe.

## 6. Secondary Initial Backfill:

The basic function of the material in this zone is to distribute overhead loads and to isolate the pipe from any adverse effects of the placement of the final backfill.

## 2. Initial Backfill:

This is the critical zone of embedment soil surrounding the pipe from the foundation to at least 6 inches over the pipe. The pipe's ability to support loads and resist deflection is determined by the quality of the embedment material and the quality of its placement. Within the initial backfill zone are bedding, haunch, primary, and secondary zones.

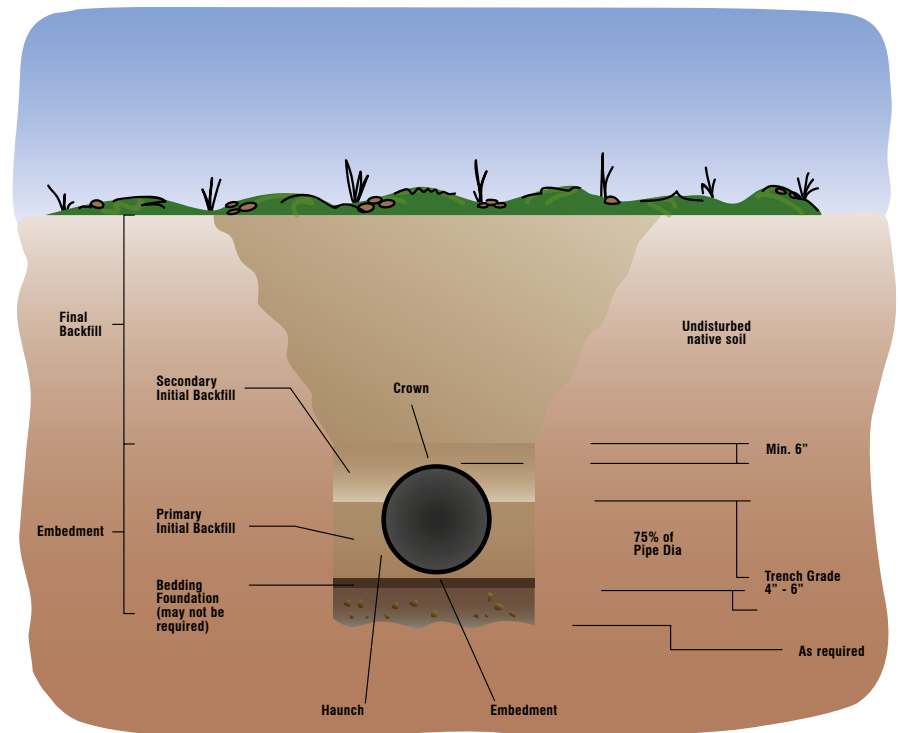

*Underground Piping Installation Diagram*

## 7. Final Backfill:

As the final backfill is not an embedment material, its nature and quality of compaction has a lesser effect on the flexible pipe. However, arching and thus a load reduction on the pipe is promoted by a stiff backfill. To preclude the possibility of impact or concentrated loadings on the pipe, both during and after backfilling, the final backfill should be free of large rocks, organic material, and debris. The material and compaction requirements for the final backfill should reflect sound construction practices, satisfy local ordinances & sidewalk, road building, or other applicable regulations.



# Installation Manual

## Above Ground Applications for HDPE Pipe:

In above ground applications, HDPE piping may be suspended or cradled in support structures or, it may simply be placed directly on the ground surface. When HDPE pipe is utilized outdoors in aboveground applications, it will be subjected to extended periods of direct sunlight. The ultraviolet component in sunlight can produce a deleterious effect on the HDPE unless the material is sufficiently protected. Black pipe (containing 2.0% minimum carbon black) is normally recommended for aboveground use.

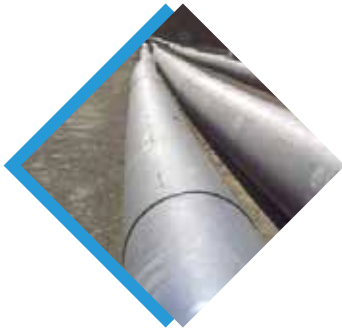

Conditions and effects which can influence the behaviour and thus, the design of above ground HDPE piping systems include:

- ▶ Temperature
- ▶ Chemical exposure
- ▶ Ultraviolet radiation
- ▶ Potential mechanical impact or loading
- ▶ Internal Pressure



## Anchorage and Thrust Blocks:

One of the fundamental features of fully integrated fusion welded HDPE pipe systems is that they are end load resistant and anchorage is not normally required at the junctions or bends. However, an exception to this are at transition points to non end load bearing piping system where thrust anchoring will be required.

The designer should consider all aspects of the system, including the imbalanced loads imposed by testing procedures, unusual configurations, large temperature variations, etc. and where excessive stress on the pipe system is envisaged, additional anchorage should be considered.

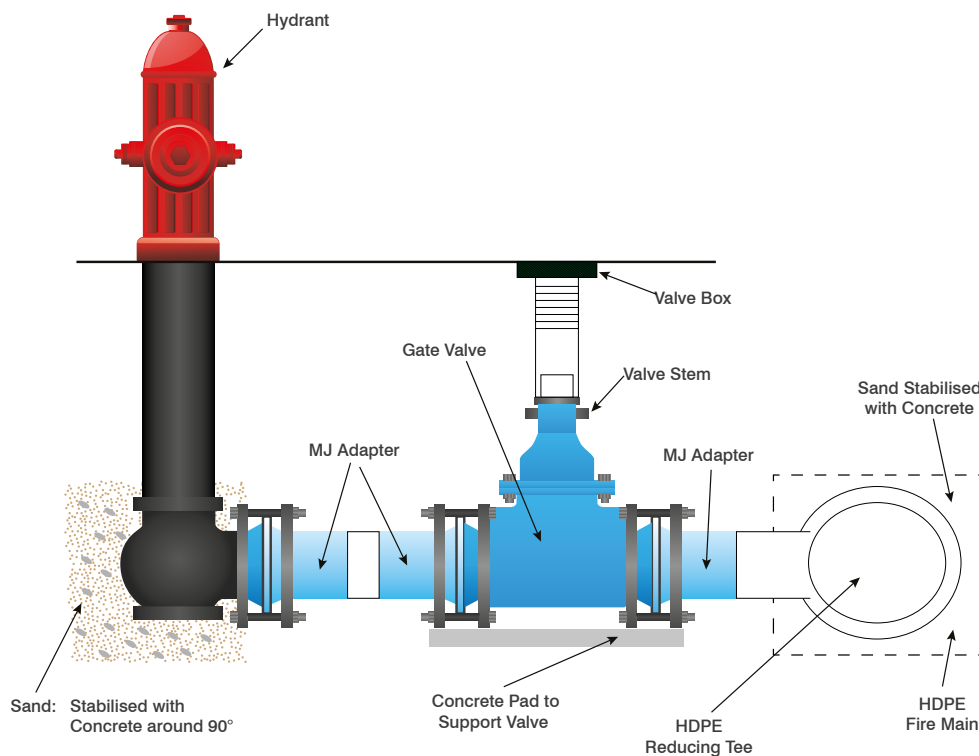

**Installation of Hydrants**

# Installation Manual

## Testing & Commissioning:

The standard procedures for testing installed pipelines prior to commissioning. These standards will normally require, as a minimum, the adequate flushing of the service and the testing of all pipes and Joints to the maximum head to which the service is to be subjected.

After being tested, all service pipes must be subjected to a final disinfection process before being introduced into the supply system. Special attention must be paid to the proper sterilization of those services laid to hospitals.

## Hydrostatic Pressure Pipeline Testing:

Polyethylene is a resilient material, lightweight and easy to handle. Nonetheless, care should be taken not to cause scuffing or gouging of the surface. In addition to the guidelines set out here, the handling and storage of HDPE pipes are covered by codes of practice issued by various utilities (e.g. the WRc manual for HDPE pipe systems for water supply). For example, with blank flanges provided with connections for pressure gauge, pump, breathers etc.

The normal testing procedure used for most pipeline materials requires the application of a nominated hydraulic pressure in the pipeline, then isolating the pressure pump for a period of 1 hour. The success of the test is then judged by the quantity of water required to restore the original test pressure measured against a given formula.

The pipeline must be anchored avoiding the movement of under pressure pipelines, and proceeding with partial trench covering leaving the jointing uncovered for further inspection. The pipeline is filled with water from the most lower-laying point where the manometer must be installed. Particular care is applied for the out coming of air from breathers, cocks etc.

The pipeline is placed under pressure at a value up to 1.5 times the nominal pressure at 20°C for 1 hour. If there is a pressure loss, it is important to measure the necessary quantity of water to restore the testing pressure.

The quantity must not exceed the water quantity, derived from the formula:

$$Q(H_2O) = 0.125 \times L / 1000 \times P / 3 \times D / 25 \times N$$

Where:

Q = Quantity

L = Length in meters

P = Testing pressure in bar

D = Inside diameters in millimetres

N = Number of hours

H<sub>2</sub>O = Water

If the test results are positive for 1 hour, the test will continue for next 12 hours under the same pressure value, along with the checking carried out as per the above given calculation.



## WARNING



For safety reasons, high density polyethylene pipelines should be tested with water. Air testing is not recommended. Pressure tests are normally conducted at 1.5 times the design service pressure. The total time at test pressure should not exceed 3 hours. Take appropriate safety precautions to eliminate danger to personnel during testing. Risks include sudden movement of pipe, failed bolts and threads on flanges and valves.

# Installation Manual

## HDPE Piping Hydro-testing Procedures:

Hydro pressure testing should be conducted as follows:

- ▶ Proper backfilling should be provided to the testing pipe & keep the Joints open for inspection.
- ▶ It is necessary to fill, pressurize and test the section within the allotted time for the test.
- ▶ One end of the test section to be closed with the End cap or blind flange and the other end of the test section to be connected with the testing flange having water inlet connected to the calibrated pressure gauge & air out let.
- ▶ Fill the test section slowly with water and ensure that no air is trapped in the test section.
- ▶ Air release valve to be connected to the system at the highest point to expel the trapped air and to get the system completely filled with water.
- ▶ During pressure testing, gradually increase the pressure in the test section to the required test pressure.
- ▶ Add make up water as necessary to maintain maximum test pressure.
- ▶ Monitor the test section at test pressure for the test duration.
- ▶ As per ISO standard, pressure test can be conducted 1.5 times the rated pressure for 2 hours at 20°C.
- ▶ For testing at high temperature, Suitable pressure reduction co-efficient has to be considered.
- ▶ As general practice the testing should be carried out at the earlier hours & late hours of the day to get the established temperature.

Refer below table for SDR 9 PIPES & FITTINGS

Test pressure recommended at various temperatures:

Test Temperature	Pressure De-ration due to increase in Temp	De-rated pressure	Test pressure (1.5 x Rated Pressure)	Test duration
20°C	1.000	20.0	30.00	2 hrs. Max
25°C	0.930	18.6	27.90	2 hrs. Max
30°C	0.870	17.4	26.10	2 hrs. Max
35°C	0.800	16.0	24.00	2 hrs. Max
40°C	0.740	14.8	22.20	2 hrs. Max
45°C	0.675	13.5	20.25	2 hrs. Max
50°C	0.610	12.2	18.30	2 hrs. Max

Refer below table for SDR 11 PIPES & FITTINGS

Test pressure recommended at various temperatures:

Test Temperature	Pressure De-ration due to increase in Temp	De-rated pressure	Test pressure (1.5 x Rated Pressure)	Test duration
20°C	1.000	16.00	24.0	2 hrs. Max
25°C	0.930	14.88	22.3	2 hrs. Max
30°C	0.870	13.92	20.8	2 hrs. Max
35°C	0.800	12.80	19.2	2 hrs. Max
40°C	0.740	11.84	17.7	2 hrs. Max
45°C	0.675	10.80	16.2	2 hrs. Max
50°C	0.610	9.76	14.6	2 hrs. Max

NOTE: Selection of the pipe should be based on the shut off pressure of the Fire pump using for the job

# Health & Safety

High Density Polyethylene pipes and fittings have been used safely and effectively throughout the world, in a wide variety of installation conditions for almost 40 years and shall continue to do so in the future.

At all times, the health and safety of operatives and other people involved in the processing, handling, jointing, installation, testing and end user of HDPE piping systems has been of utmost importance to SHIELD. To achieve and maintain these objectives, good working practice is essential. The guidelines for the usage of polyethylene piping systems have been published by several regulatory bodies and they should always be strictly followed.

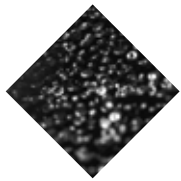

## The Material:

Polyethylene is chemically non-reactive and generally regarded as biologically inert. It is not classified as dangerous product (EEC).



## Ingestion:

Ingestion of polyethylene in any form should be avoided.



## Inhalation:

Inhalation of HDPE dust can irritate the respiratory system. Wherever possible, when cutting or scrapping HDPE pipes, operatives should work in the open air or in well ventilated areas with proper Personal Protective Equipment (PPE).



## Physical Contact:

Polyethylene is not regarded to be a skin irritant.

When cutting or scrapping HDPE pipes or fittings, HDPE dust particles may cause eye irritation and it is recommended that protective eye-wear must be used.



## Recycling:

The product is suitable for recycling using modern methods of shredding and cleaning. In-house production waste should be kept clean to facilitate direct recycling.



## Disposal of Waste Material:

Surplus or waste HDPE material can be reprocessed for new pipes or other products. Alternatively the disposal should be as per the standard local regulations.



## Fire Hazards:

Polyethylene burns, but it is not classified as flammable. It has a flash point of 360°C approx.

Above 300°C, HDPE will degrade to produce carbon monoxide, water and small amounts of various hydrocarbons and aldehyde. Avoid the accumulation of HDPE dust particles as they could give a potential risk of dust explosion.

All electrical equipment in the area should be carefully earthed. In the vent of fire involving HDPE materials, apply water in a spread jet. Dry chemical, foam and carbon dioxide can also be used.



## The Environment:

High Density Polyethylene is not considered dangerous for the environment.

### NOTE:

- ▶ Drawings are for illustration purpose only.
- ▶ This is only a general information and qualified medical attention should be obtained as soon as practically possible.

# Health & Safety



## Handling:

HDPE pipes and fittings should be handled and moved in accordance with the instructions detailed in the manuals of regulatory bodies and in the Handling and Storage section of this publication. Particular care should be taken while handling large diameter pipes.

Safety clothing and equipment should be used at all times when handling and moving HDPE pipes. When transporting, handling and releasing coils of HDPE pipes, extreme caution should be taken, particularly with pipes 90 mm and above, dispensing trailer must be used and the details in Handling and Storage section must be strictly followed.

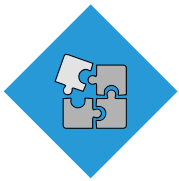

## Jointing:

Butt fusion or Electro-Fusion jointing of HDPE pipes and fittings should always be carried out in well ventilated areas. The fusion process is a high temperature operation and fumes are generated around the jointing area. Inhalation of the fumes should be avoided.

During the butt-fusion operation, molten HDPE is formed. This should not be allowed to come into contact with the skin as it will adhere strongly and cause severe burns. Protective gloves should be worn during the jointing process and when using the heater plates of the welding machinery.

During the Electro-Fusion process, care should be taken to prevent the ejection of molten material from the joint. Protective clothing including gloves and safety eye-wear should be worn during the jointing process.



## First Aid:

The following are recommendations for immediate first aid to be applied in the event of an accident involving polyethylene products.

Ingestion: Wash the mouth with clean water.

Inhalation: Move the affected person into fresh air situation. If in distress, apply oxygen or artificial respiration.

Eye Injury: If HDPE particles get into the eyes, immediately flush with clean water, repeating as necessary.

Burns: If molten HDPE material comes into contact with skin, cool the affected area immediately by flow of cold water. DO NOT attempt to remove the HDPE material from the skin. Seek medical attention as quickly as possible, even for the smallest burn.

## DISCLAIMER



This technical product guide should only be used as a reference and for any clarification, refer to the relevant standards for further information.

### NOTE:

- ▶ Drawings are for illustration purpose only.
- ▶ This is only a general information and qualified medical attention should be obtained as soon as practically possible.

# Handling & Storage

## General Handling:

Although relatively lightweight, polyethylene pipe products should be treated with a similar level of caution as for heavier metallic pipe products. Whilst polyethylene is a robust and resilient material, care should be taken not to cause excessive scuffing or gouging of the surface. Surface damage may occur during handling, storage and installation, but providing the depth, value should not be more than 10% of the wall thickness, only then the service performance of the pipe or fitting will not be affected. Further guidance regarding handling and storage of HDPE pipes and fittings is given by various industry bodies, including the following:

HSE Guidance - Avoidance of danger from overhead power lines (HS GS 6); Protect yourself, protect the load; The lifting operations and lifting equipment regulations (LOLER); The provision and use of work equipment regulations (PUWER).

Department of Transport - Safety of loads on vehicles.  
WRc - Polyethylene Pipe Systems For Water Supply (version 01/02).  
IGEM/G/8 Handling, Transport and Storage of PE Pipes and Fittings.

## Factors of Safe Lifting & Loading:

In lifting operations, where either manual or mechanical effort is involved in moving a load, the following factors are common to all situations and provide the basis on which the selection of the appropriate type of lifting equipment can be made:



NOTE: Drawings are for illustration purpose only.

# Rules of Handling & Storage



Never drag or roll individual pipes or bundles



Always store pipes/fittings on flat, firm ground, able to withstand the weight of the material and lifting apparatus



Never throw or drop pipe and fittings from vehicle

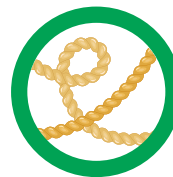

Always use non-metal slings when handling pipes/fittings (e.g. nylon or polypropylene)



Never use metal hooks, slings or chains when handling pipes/fittings



Always exercise special care when handling pipes in wet or frosty conditions, since they may become slippery



Never stack pipe bundles more than 3 meters or 3 bundles high



Always keep protective packaging (battens, shrink-wrap, pallets, strapping, etc.) intact until pipes/fittings are required to be used.



Never place pipes/fittings in contact with lubricating or hydraulic oil, gasoline, solvent, or other aggressive materials

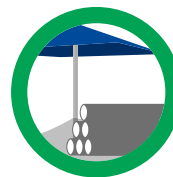

Always store pipes/fittings away from intense heat



Never stack coils more than 2 meters high

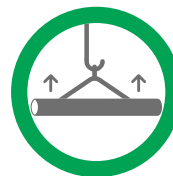

Always allow some bending deflection when pipes are loaded and unloaded



Never store pipes and fittings near sharp objects

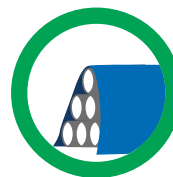

Always protect pipes/fittings with opaque sheeting or tarpaulin

# Handling & Storage

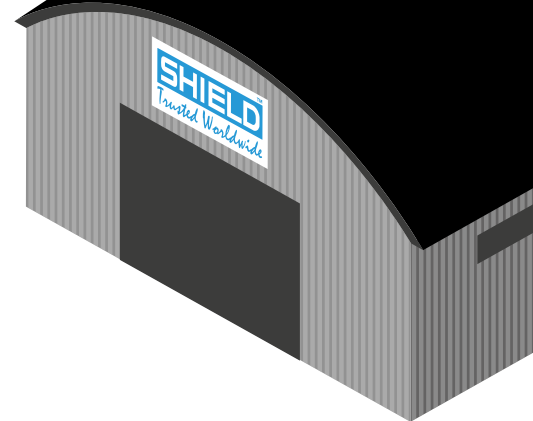

## Delivery & Unloading at Customer Sites:

The Plastic Pipe Industry - Recommended Guidelines for the Safe Delivery and Unloading of Plastic Pipes to Customer's Site (Health & Safety Charter) has been developed by industry stakeholders to provide a risk-based framework to assist with the safe delivery and off-loading of plastic pipe products. This document has been recommended by the HSE and SHIELD formally adopted these guidelines.

Deliveries should not be made to unmanned sites.

### Length & Bundles:

It is the responsibility of the Site In-charge to ensure that the site is safe to accept pipe deliveries. The area where the delivery vehicle is to be stopped shall be safe and the location for storage shall be on firm level ground, which is free from damaging material.

Polyethylene pipe products should be off-loaded in a controlled manner. All polyethylene pipe products shall be mechanically off-loaded and if there is no suitable mechanical off-loading equipment available on-site then an on-board crane vehicle shall be requested. It is the responsibility of the on-board crane operator to off-load polyethylene pipes and he is the only person authorised to access the trailer for this purpose. It is important to maintain an exclusion zone with all personnel and vehicular traffic kept at a safe distance.

### Coils:

The delivery driver is responsible for undoing the load securing devices, which should only be removed from the product that is to be imminently off-loaded. The driver is the only person authorised to access the trailer and if off-loading is to be carried out by fork-lift then the driver should be escorted to a safe zone away from the off-loading area by the Site In-charge.

It is the responsibility of the person operating the fork-lift to ensure that the off-loading process is carried out safely. If off-loading is to be carried out by the driver using the on-board crane, then the procedures for handling lengths and bundles should be followed.

Larger coils 90mm - 180mm pipe will require lifting by a fork-lift ensuring that the tines are covered to protect the coils from damage. It is recommended to use anti-slip protective fork covers, which are readily available.

Small coils of pipe delivered on pallets may be handled by forklift, but they should remain secured to the pallet during transportation. Securing bands should only be cut at the time of use. Coils delivered in shrink-wrapped packs should be handled with care to avoid damage.

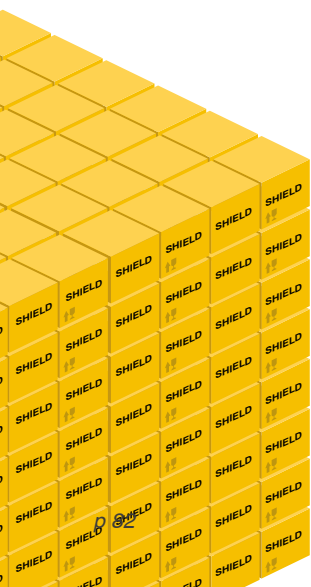

NOTE: Drawings are for illustration purpose only.  
SHIELD reserves the right to change the contents without notice.



# Handling & Storage

## Site/Depot Handling:

A flat-bed vehicle, free from sharp objects and projections should be used for transporting pipes. When lifting pipe bundles by crane, wideband slings of polypropylene, nylon or similar material is recommended. Do not use chains, hooks or hawsers.

Where large diameter coils are to be stored vertically at depots, the coils must be secured with purpose built racking with protective matting positioned underneath, and facilities for safe lifting, movement and loading must be available.

## Storage:

### Fittings:

Boxed fittings and pre-fabricated fittings may be stacked on pallets for transport which should be adequately secured. They should be stacked, secured and transported such that no loads are imparted to the fittings. Never use hooks to lift fittings.

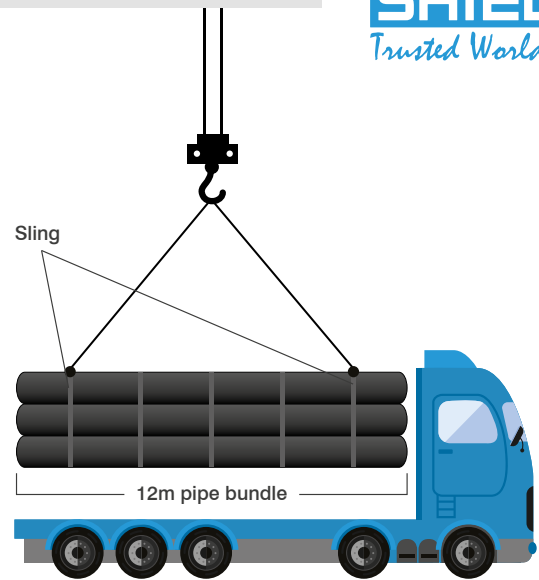
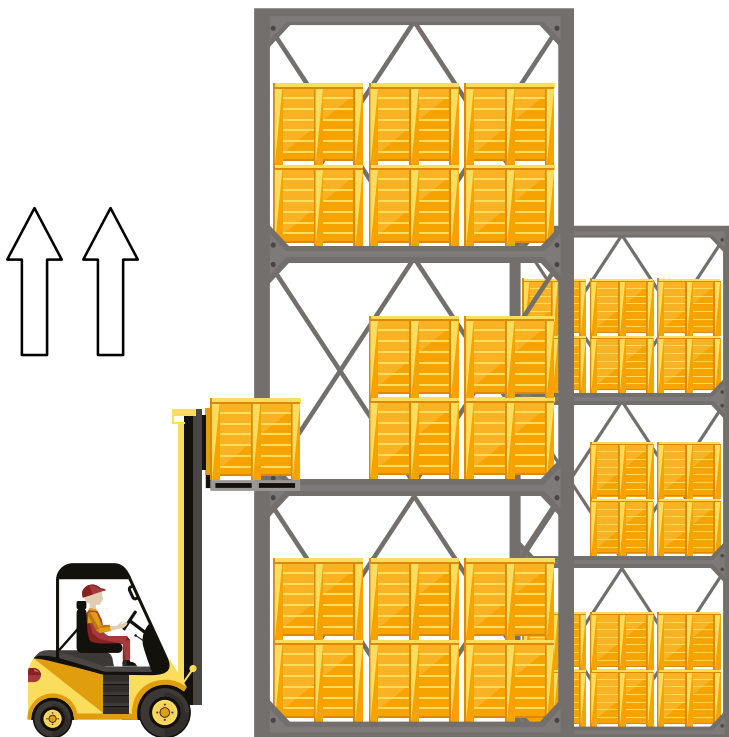

Good Lifting Practice

### Pipes:

The on site storage facilities will vary depending upon factors such as the available space, location, size and nature of the project etc.

The storage may range from a secure central storage compound, localised storage points close to the laying operation, to stringing the pipes along the planned route. In all cases careful consideration should be given to the following aspects:

- ▶ Security of all materials and equipment from theft, vandalism, accidental damage or contamination (Pipe-end caps, intended to prevent ingress, should be kept in place during storage).
- ▶ Safety of the general public, especially, the elderly and disabled.
- ▶ The movement of traffic, construction equipment, farm machinery and animals.
- ▶ All pipe store locations should be on suitably firm, level ground, free from damaging material with adequate access for construction vehicles and/or lifting equipment.
- ▶ Badly stacked pallets, coils or bundles may slip or collapse, which will cause injury to personnel or damage to the pipe.

Pipe lengths stored individually should be stacked in a pyramid not more than one metre of height, with the bottom layer fully restrained by wedges. Where possible, the bottom layer of pipes should be laid on timber battens. On site, pipes may be laid out individually in strings. (Where appropriate, protective barriers should be placed with adequate warning signs and lamps.)

Bundled packs of pipe should be stored on clear, level ground, with the battens supported from the outside by timbers or concrete blocks. For safety, bundled packs should not be stacked more than three metres of height.

# Handling & Storage

## Large Coils:

Coiled pipe should be stored flat, especially during periods of warm weather, and on firm level ground, which has suitable protection for the bottom coil. Where space is limited and colours are to be stacked, the height of stacked coils should be such that the stack is stable and the uppermost coil can be safely handled. The height of the stack should not exceed 2.0 metres under any circumstance.

Wedged-end wooden battens placed below the bottom coil and used as spacers between each layer will facilitate easy access for slinging.

When the need for transportation is required, it should only be carried out by trained operatives.

Batches of coils delivered on pallets must remain secured to the pallet and only to be cut at the time of use.



## Coil Dispensing:

**Safety first:** Pipe held in coils, is under tension and is strapped accordingly. Coils may be hazardous if released in the incorrect manner — particularly if the end of the pipe is not kept restrained at all times. It is most important to read and understand the following guidelines before attempting to untie coils.

Coils are secured by one of two methods depending on the pipe's diameter:

### 1. Outer bands with additional strapping of individual layers (63mm to 110mm).

Do not remove any of these bands until pipe is required for use. Remove them carefully, from the outermost layer first, so that only the length of pipe needed immediately is released. Successive layers can be released by removing band as the pipe is drawn away from the coil.

Coils of pipe should only be dispensed in the field from proprietary trailers.

### 2. Wrapped coils

Pipe sizes in 32mm and below are protected with the film-wrap, enabling the free end of the pipe to be taken out from the coil. Take the only sufficient pipe for immediate use from the coil and on no account, should remove the outer wrapping until the coil is almost fully unwound.



# Handling & Storage

## Fittings:

Electro-Fusion fittings should be stored under cover in dry conditions, preferably on racking. They should be kept in their boxes/packaging until ready for use.

Fabricated fittings may be stored outdoors, as long as they are protected against damage and prolonged direct sunlight.

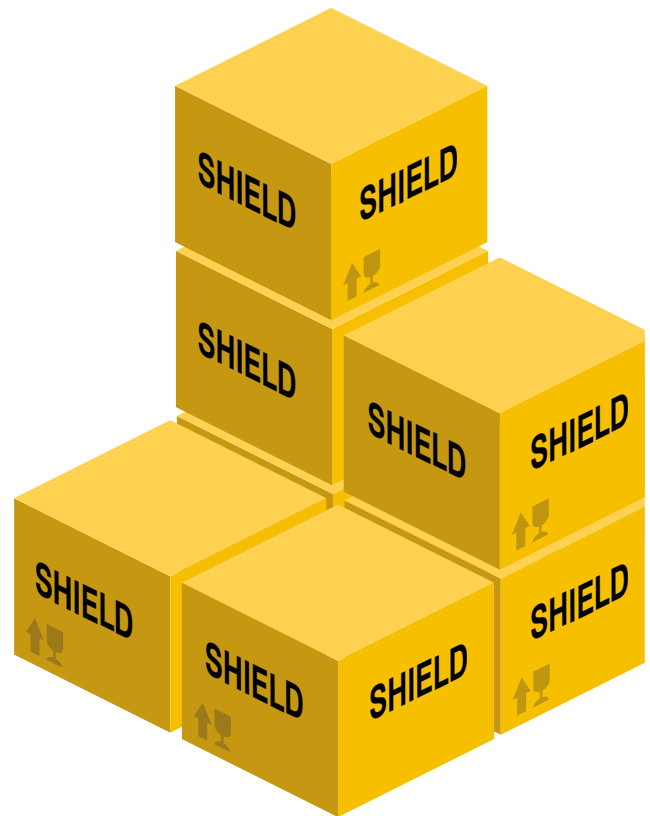

## Storage Outside:

Black polyethylene material contains ultraviolet stabiliser to provide excellent protection against degradation due to UV radiation.

Blue and yellow polyethylene is UV stabilised to resist degradation in storage only. The maximum recommended storage outside is 12 months. Product to be stored outside for periods in excess of this, should be covered with polyethylene sheet or stored under cover.

Additional precautions may be required, where polyethylene pipes are stored outdoor in regions of high solar radiation.

# Certificates & Approvals

## CERTIFICATE



This is to certify that



**Shield Fire Safety and Security Ltd.**  
(Shield Middle East FZCO)  
Jebel Ali Free Zone South  
Near Round about S06  
Street 403  
Dubai  
UAE

has implemented and maintains an **Occupational Health and Safety Management System.**

Scope:  
The Occupational Health and Safety activities and supporting processes associated with Manufacture of Pipes and Fittings, Trading of sprinklers and accessories including Deluge Valve and Wet Alarm System, Fire Protection system including Clean Agent and Inert Gas, Emergency and Exitlights, Central Battery Systems, Fire Alarm Panels, Valves for Water and Gas Application.

Through an audit, documented in a report, it was verified that the management system fulfills the requirements of the following standard:

### ISO 45001 : 2018

Certificate registration no. 20005458 OHS18  
Except from certificate registration no. 20002009 OHS18  
Date of original certification 2014-01-06  
Date of certification 2020-03-20  
Valid until 2023-03-19



### DQS Inc.

*Brad McGuire*  
Brad McGuire  
Managing Director

Accredited Body: DQS Inc., 1500 McCormor Parkway, Suite 400, Schaumburg, IL 60173 USA  
Administrative Office: Deutsch Quality Systems (India) Pvt. Ltd., 5th Floor, Anjaneys Techno Park, 147, HAL Airport Road, Kothlali, Bangalore - 560 017 - India



**Shield Fire Safety and Security Ltd.**  
(Shield Middle East FZCO)  
Jebel Ali Free Zone South  
Near Round about S06  
Street 403  
Dubai  
UAE

has implemented and maintains an **Environmental Management System.**

Scope:  
The Environmental activities and supporting processes associated with Manufacture of Pipes and Fittings, Trading of Sprinklers and Accessories including Deluge Valve and Wet Alarm System, Fire Protection System including clean agent and Inert Gas, Emergency and Exit Lights, Central Battery Systems, Fire Alarm Panels, Valves for Water and Gas Application.

Through an audit, documented in a report, it was verified that the management system fulfills the requirements of the following standard:

### ISO 14001 : 2015

Certificate registration no. 20005458 UM  
Except from certificate registration no. 20002009 UM  
Date of original certification 2014-01-06  
Date of certification 2020-03-20  
Valid until 2023-03-19



### Certificate of Compliance

This certificate is issued for the following:

#### Polyethylene Pipe and Fittings

(see attached product listing)

**Prepared for:**  
Shield Fire Safety and Security Ltd  
Unit 3 Endeavour Dr  
Building: SS14 3WE  
United Kingdom

**Manufactured by:**  
Shield Fire Safety and Security LfBox  
Jebel Ali, Dubai  
United Arab Emirates

FM Approvals Class: 1613

Approval Identification: 3041288  
Superseded by: RR210750  
Superseded by: RR220985

Date Approved: July 6, 2011  
Date Approved: August 29, 2017  
Date Approved: November 21, 2019

To verify the availability of the Approved product, please refer to [www.approvalguide.com](http://www.approvalguide.com)

Said Approval is subject to satisfactory field performance, continuing Surveillance Audits, and strict conformity to the constructions as shown in the Approval Guide, an online resource of FM Approvals.

**David B. Fuller**  
AVP, Manager of Fire Protection  
FM Approvals  
1151 Boston-Providence Turnpike  
Norwood, MA 02062 USA

## CERTIFICATE

This is to certify that



has implemented and maintains

Scope:  
Manufacture of Pipes, Fittings and Ventilation Equipment Trading of Sprinklers and Accessories, Deluge Valve and Wet Alarm Valve Systems, Fire Protection Agent and Inert Gas, Emergency and Exit Lights, Central Battery Systems, Fire Panels, Valves for Water and Gas Application.

Through an audit, documented in a report, it was verified that the management fulfills the requirements of the following standard:

### ISO 9001 : 2015

Certificate registration no. 20005458 QM15  
Date of original certification 2016-10-12  
Date of certification 2019-10-12  
Valid until 2022-10-11

### DQS Inc.

*Brad McGuire*  
Brad McGuire  
Managing Director

Accredited Body: DQS Inc., 1500 McCormor Parkway, Suite 400, Schaumburg, IL 60173 USA  
Administrative Office: Deutsch Quality Systems (India) Pvt. Ltd., 5th Floor, Anjaneys Techno Park, 147, HAL Airport Road, Kothlali, Bangalore - 560 017 - India

### Certificate of Compliance

Approved Number: 1612201  
Test Report: M37L38-0915

**Prepared for:**  
Shield Fire Safety & Security Ltd  
PO Box 201044,  
Jebel Ali Free Zone,  
Dubai,  
UAE

**Manufactured by:**  
Shield Fire Safety and Security Ltd  
Unit 12,  
Millar Road,  
Parsippany Industrial Estate,  
Orange, New Jersey,  
07054-1402  
USA

WATER REGULATIONS ADVISORY SCHEME LTD. (WRAS)  
NATIONAL APPROVAL

The material referred to in this letter is suitable for contact with wholesome water for domestic purposes having met the requirements of BS6841:2009 and/or BS7174:2014. Suitability of non-metallic products for use in contact with water intended for human consumption will depend on their effect on the quality of the water.

The reference relates solely to its effect on the quality of the water with which it may come into contact and does not signify the approval of its mechanical or physical properties for any use.

**POLYETHYLENE - COMPONENTS**      **5298**

Shield PE 100 Suggested Usage: Heat resistant, selected PE 100 fittings. For use with water up to 80°C.

### Certificate of Compliance

Approved Number: 1612202  
Test Report: M37L38-0915

**Prepared for:**  
Shield Fire Safety & Security Ltd  
PO Box 201044,  
Jebel Ali Free Zone,  
Dubai,  
UAE

**Manufactured by:**  
Shield Fire Safety and Security Ltd  
Unit 12,  
Millar Road,  
Parsippany Industrial Estate,  
Orange, New Jersey,  
07054-1402  
USA

WATER REGULATIONS ADVISORY SCHEME LTD. (WRAS)  
NATIONAL APPROVAL

The material referred to in this letter is suitable for contact with wholesome water for domestic purposes having met the requirements of BS6841:2009 and/or BS7174:2014. Suitability of non-metallic products for use in contact with water intended for human consumption will depend on their effect on the quality of the water.

The reference relates solely to its effect on the quality of the water with which it may come into contact and does not signify the approval of its mechanical or physical properties for any use.

**POLYETHYLENE - COMPONENTS**      **5298**

### CERTIFICATE OF COMPLIANCE

Certificate Number: 201710621-EK26548  
Report Reference: EK26548-20170817  
Issue Date: 2017-AUGUST-21

Issued to: SHIELD FIRE SAFETY & SECURITY LTD  
REDBURN HOUSE  
2A TORBRIDGE ROAD  
ROMFORD  
RM3 8QE UNITED KINGDOM

This is to certify that representative samples of **POLYETHYLENE PIPE AND FITTINGS** Polyethylene pipe:

Material	Pipe Size (in.)	Pressure Class
Polyethylene pipe		
HDP 6"	4, 6, 8, 10, 12, 14, 16, 18, 20	200, 250, 335

\* Products have not been investigated for suitability for use with potable water.

Have been investigated by UL, in accordance with the Standard(s) indicated on this Certificate.

Standard(s) for Safety: Polyethylene (PE) Pressure Pipe and Fittings, 4 in. Through 63 in. (100 mm Through 1,650 mm), for Waterworks - AWWA C900

Additional Information: See the UL Online Certifications Directory at [www.ul.com/certification](http://www.ul.com/certification) for additional information

Only those products bearing the UL Certification Mark should be considered as being covered by UL's Certification and Follow-Up Services.

Look for the UL Certification Mark on the product.

1 of 2

## CERTIFICATE

DQS Holding GmbH has issued an IQNet recognized certificate that the organization

**Shield Fire Safety and Security Ltd.**  
Jebel Ali Free Zone South, Near round about S06  
Street 403  
Dubai  
United Arab Emirates

has implemented and maintains a **Quality Management System.**

Scope:  
Manufacture of Pipes, Fittings and Ventilation Equipment Trading of Sprinklers and Accessories, Deluge Valve and Alarm Valve Systems, Fire Protection, Clean Agent and Inert Gas, Emergency and Exit Lights, Central Battery Systems, Fire Alarm Panels, Valves for Water and Gas Application.

Through an audit, documented in a report, it was verified that the management system fulfills the requirements of the following standard:

### ISO 9001 : 2015

Issued on: 2019-10-12  
First issued on: 2016-10-12  
Expires on: 2022-10-11

This attestation is directly linked to the IQNet Partner's original certificate and shall not be used as a stand-alone document.

Registration number: DE-20005458 QM15

*Alex Stoichilou*  
Alex Stoichilou  
President of IQNet

Michael Drechsel  
Managing Director of  
DQS Holding GmbH

IQNet Partners:  
AENOR Spain AFNOR Certification France APCER Portugal CCC Cyprus CIBQ Italy  
COC China CCM China CQS Czech Republic Csa Cert Canada DQS Holding GmbH Germany FCV Brazil  
FONDOPRIMA Venezuela ICONTEC Colombia Inspecta Serfiflor Oy Finland INTECO Costa Rica  
IRAM Argentina JSA Japan KFD Korea MRTC Greece MSZ Hungary Nemko AS Norway NSAI Ireland  
NYCE-SIGE Mexico PCBC Poland Quality Austria Austria Hungary SRI Israel SIB Slovenia  
SIRM QAS International Malaysia SGS Switzerland SRAC Romania TEST St Petersburg Russia TSE Turkey YUQS Serbia  
IQNet is represented in the USA by APNOR Certification, CIBQ, DQS Holding GmbH and NSAI Inc.

\* The list of IQNet partners is valid at the time of issue of this certificate. Updated information is available under [www.iqnet-certification.com](http://www.iqnet-certification.com)

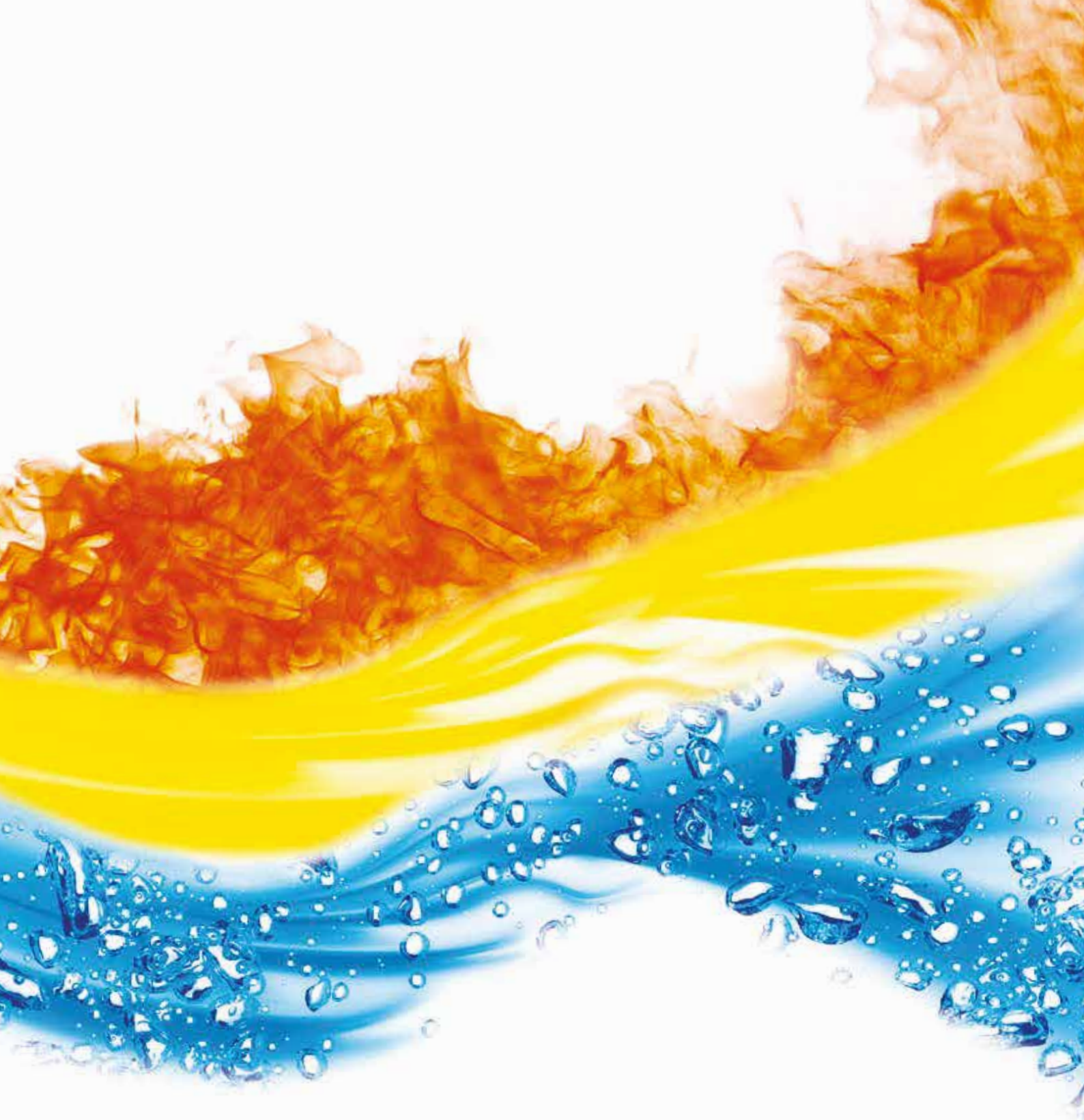

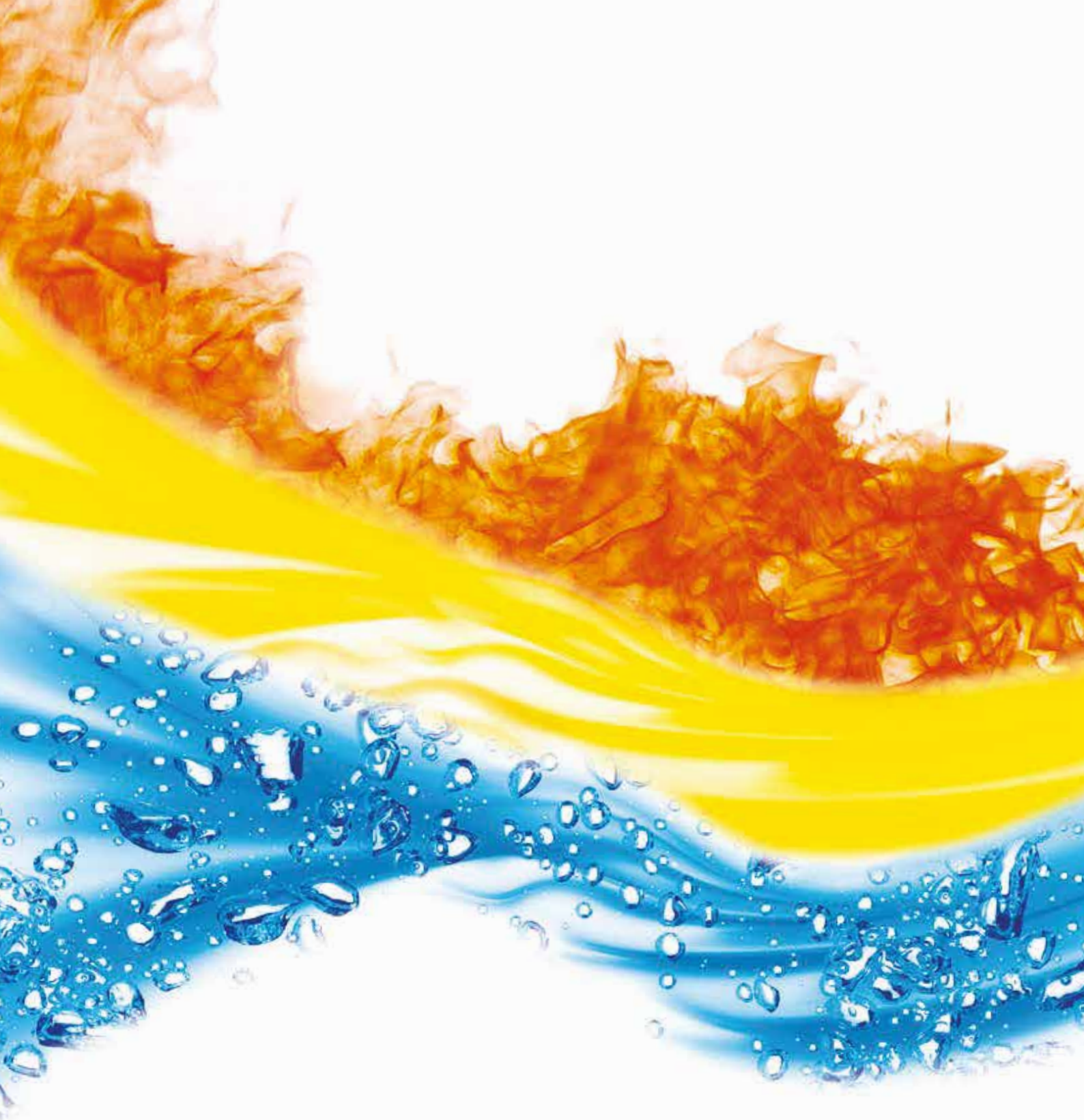



**High Density  
Polyethylene  
Piping Solution**

# Standards & Abbreviations

## General Standards:

ISO 161-1:1996	Thermoplastics pipes for the conveyance of fluid - Nominal outside diameters and nominal pressures - Part 1: Metric series.
ISO 4065:1996	Thermoplastics Pipes - Universal Wall Thickness table.
ISO 11922-1:1997	Thermoplastics pipes for the conveyance of fluids - Dimensions and tolerances - Part 1: Metric series.
BS 6437:1984	Specification for polyethylene pipes (type 50) in metric diameters for general purposes.
BS EN 1092-1:2007	Flanges and their Joints. Circular flanges for pipes, valves, fittings and accessories, PN designated. Steel flanges.

## Polyethylene Range Is Designed To Comply With The Requirements Of One Or More Of The Standards:

ISO 4427-1,2,3,5 (2007-08)	HDPE pipes and fittings for water supply - General, Pipes, Fittings and Fitness for the purpose of the system.
ISO 4437-1:2014	Plastics piping systems for the supply of gaseous fuels - Polyethylene (PE) - Part 1: General.
BS EN 15494:2015	Plastics piping systems for industrial applications. Polybutene (PB), polyethylene (PE), polyethylene of raised temperature resistance (PE-RT), cross-linked polyethylene (PE-X), polypropylene (PP). Metric series for specifications for components and the system.
BS EN 12201-1:2011	Plastic piping systems for water supply. Polyethylene (PE). General.
BS EN 805:2000	Water supply - requirements for systems and components outside buildings.
BS EN 681-2:2000	Elastomeric seals. Material requirements for pipe Joint seals used in water and drainage applications. Thermoplastic elastomers.
BS 5306-2:1990 or BS EN 12845:2015	Fixed fire-fighting systems. Automatic sprinkler systems. Design, installation and maintenance.
BS EN ISO 8085-1:2001 or ISO 4437-3:2014	Polyethylene fittings for use with polyethylene pipes for the supply of gaseous fuels - Metric series - Specifications - Part 1: Fittings for socket fusion using heated tools.
BS EN ISO 8085-2:2001 or ISO 4437-3:2014	Polyethylene fittings for use with polyethylene pipes for the supply of gaseous fuels - Metric series - Specifications - Part 2: Spigot fittings for butt fusion, for socket fusion using heated tools and for use with Electro-Fusion fittings.
BS EN ISO 8085-3:2001 or ISO 4437-3:2014	Polyethylene fittings for use with polyethylene pipes for the supply of gaseous fuels - Metric series - Specifications - Part 3: Electro-Fusion fittings.
BS EN 1555-1,2,3,5 (2010-12)	Plastic piping systems for supply of gaseous fuels - Polyethylene - General, Pipes, Fittings and Fitness for the purpose of the system.
BS EN 682:2002	Elastomeric seals. Materials requirements for seals used in pipes and fittings carrying gas and hydrocarbon fluids.
DIN 8074:2011-12	Polyethylene (PE) - Pipes PE 80, PE 100 - Dimensions.
DIN 8075:2017-08	Polyethylene (PE) pipes - PE 80, PE 100 - General quality requirements.
DIN 16963:1980	Part-1 High density polyethylene (HDPE) fittings dimensions, type 2.
DIN 3543-4:1984-08	High density polyethylene (HDPE) tapping valves for HDPE pipes.
IGN 4-08-01:1994	Bedding & side fill materials for buried pipelines.
ISO 12176-1,2,3,4 (2003-17)	Plastic pipes and fittings - Equipment for fusion jointing – Butt-fusion, Electro-Fusion, Operators badge, Traceability coding.
ISO 13477/78/79/80	Thermoplastics pipes for conveyance of fluids - Determination of resistance to rapid crack propagation - Small scale steady state test, Full scale test, Test method for slow crack growth in notched pipes (notch test), Resistance to slow crack Growth - Cone test method.
WIS 4-08-02:1994	Specification for bedding and side fill materials for buried pipelines.
WIS 4-24-01:1998	Specification for mechanical fittings and Joints for polyethylene pipes for nominal sizes 90 to 1000.
WIS 4-32-08:2002	Specification for the fusion jointing of polyethylene pressure pipeline systems using PE 80 and PE 100 materials.
WIS 4-32-14:1995	Specification for PE 80 and PE 100 Electro-Fusion fittings for nominal sizes up to and including 630.
WIS 4-32-15:1995	Specification for PE 80 and PE 100 spigot fittings and drawn bends for nominal sizes up to and including 1000.
WIS 4-32-16:1998	Specification for butt fusion jointing machines.
WIS 4-32-18:2003	The choice of pressure ratings for polyethylene pipe systems for water supply and sewerage duties.

## List Of Abbreviations:

<b>ANSI</b>	American National Standard Institute	<b>D, d, Ø</b>	Diameter
<b>ASTM</b>	American Society for Testing & Materials	<b>e, e1, e2, c, c1, c2</b>	Wall Thickness
<b>AWWA</b>	American Water Works Association	<b>h</b>	Thickness
<b>BS</b>	British Standard	<b>L, L1, L2, L<sub>n</sub>, H, Z</b>	Length
<b>DIN</b>	Deutsche Industrie Normen	<b>R</b>	Radius
<b>ISO</b>	International Standard Organization	<b>DVS</b>	German Welding Society
<b>HDPE</b>	High Density Polyethylene	<b>d</b>	Pipe Outside Diameter
<b>PVC-U</b>	Unplasticised Polyvinyl Chloride	<b>SDR</b>	Standard Dimension Ratio
<b>PVC-C</b>	Chlorinated Polyvinyl Chloride	<b>DR</b>	Dimension Ratio
<b>PP</b>	Polypropylene	<b>WIS</b>	Water Industry Specification
<b>PE</b>	Polyethylene	<b>IGN</b>	Water Industry Information & Guidance Note
<b>PVDF</b>	Polyvinylidene Fluoride	<b>FM</b>	Factory Mutual
<b>EPDM</b>	Ethylene Propylene Diene Monomer	<b>UL</b>	Underwriters Laboratories
<b>NBR</b>	Nitrile Rubber	<b>DN, d<sub>n</sub></b>	Nominal Diameter
<b>PTFE</b>	Polytetrafluorethylene	<b>PN</b>	Nominal Pressure
<b>PB</b>	Polybutylene	<b>Kg</b>	Weight In Kilogram
<b>PBT</b>	Polybutylene Terephthalate	<b>g</b>	Weight In Gram
<b>WRAS</b>	Water Regulations Advisory Scheme	<b>Mpa</b>	Mega Pascal
		<b>Psi</b>	Pounds per square inch



**SHIELD**<sup>TM</sup>

*Trusted Worldwide*



For further information on any aspect of the Shield range of HDPE Piping System, please contact your nearest office.

**UNITED KINGDOM**

Unit 3, Endeavour Drive,  
Basildon-Essex, SS14 3WF,  
United Kingdom.

Email: [shielduk@shieldglobal.com](mailto:shielduk@shieldglobal.com)

Tel: +44 1708 377731

Fax: +44 1708 347637

**MIDDLE EAST & AFRICA**

Jebel Ali Free Zone, Dubai, U.A.E.

Email: [shieldme@shieldglobal.com](mailto:shieldme@shieldglobal.com)

Tel: +971 4 881 2070

Fax: +971 4 881 2198